

Office

Brochure 2024



All the products (shown here) may not be available at the store. Please contact the staff or look at www.IKEA.com for more information. For more detailed product information, see the price tag and the internet. All units require assembly.

Your business is our business!

Everyone deserves a healthy, appealing and comfortable workplace, whether you are working out of a home office, starting up a small enterprise or greeting guests at your 10th hotel location. At IKEA, we know that the best efforts are made in surroundings that are functional, ergonomic and reflect the unique identity of your business and your customers. A space to admire, that also focuses on your well-being.

As you browse through these pages, we hope you will get inspired by our

wide range of office furniture and clever acoustic solutions – all designed with quality and flexibility in mind. As a confirmation of the high quality, we proudly offer a 10-year guarantee on all our office furniture families. Once ideas start to take shape, we are there to help – get in touch and let us help you find the right service for your business.

See you soon,
The IKEA for Business team





Quietly brilliant
Did you know our MITZON acoustic screens can help create calm zones that enhance your ability to focus? They are filled with wood fibres and dressed in a thick durable fabric that is also removable and washable.
See page xx



Stay healthy when sitting
Want to know how to achieve an ergonomic seating position that boosts your health and comfort? We show you how.
See page xx.

Table of contents

Companies' stories	06	Conference tables.....	112
Ergonomic solutions for a healthier you	24	Conference chairs.....	126
Why acoustics matter	36	Office storage.....	138
Meeting spaces in the office.....	48	Lounge areas.....	150
Flexibility in the workplace	54	Lighting and accessories	164
Office desks	62	Greenery and wall decoration.....	174
Complementary ergonomic products.....	82		
Office chairs.....	86		
Room dividers and acoustic screens	98		



Need to get away from all the buzz? MITZON work station provides a comfy space where you can focus.



At our company, well-being goes first

"Welcome to our engineering consultancy! Are you curious to know how we created a modern workplace that puts the comfort and well-being of our employees first? It's important that we feel good at work - this way we produce better and can extend our energy to the needs of our customers. Check out how we achieved a calm and harmonious environment where we thrive every day."



"Do you ever long for a cosy niche, where you can relax and focus on a task undisturbed? We love this comfy nook that provides a private space in our shared office."



"Sometimes the best ideas hatch when we least expect it. That's why we created workshop areas where we stand and meet. This keeps the energy up and the ideas flowing."



"We brought nature indoors! By dividing some of our spaces with green walls, the office became more pleasant and relaxed."



"These clever hooks keep essentials handy when we need them."



"Every office needs dedicated spaces for one-on-one chats. This room offers a peaceful space for focused discussions without disruption."



"The small compartments on our desks are perfect for storing post-its, pens and other essentials."



"The hooks on the sides of the desks keep things like backpacks off the floor."



"Desk-mounted acoustic screens give privacy and help to calm the atmosphere so our master minds can focus."



"We attached whiteboards on the room dividers to display important messages or reminders."



GRÖNFJÄLL
Office chair with armrests.
Letafors grey-green.
405.329.21



We sell world travel on a 20 m² floor plan

“As a start-up travel agency, we book trips, take calls from customers, connect with other travel agencies, and plan itineraries – all within the confines of our 20 m² office. Despite the challenge, we have optimised our limited space and created a multi-functional area that accommodates our work, storage, meetings, and social activities.”



"Monitor stands with drawers hold smaller office supplies and help keep the desk tidy. We added a convenient noticeboard where we pin important telephone numbers and to-do lists."



"Our compact office space is functional and efficient. These shallow cabinets are perfectly suited to our limited space, providing ample storage for binders, documents and clothes such as shoes and coats."



"Our team has created a cosy corner using the light-weight drawer unit. It provides an area for coffee breaks or catching up on pending tasks."

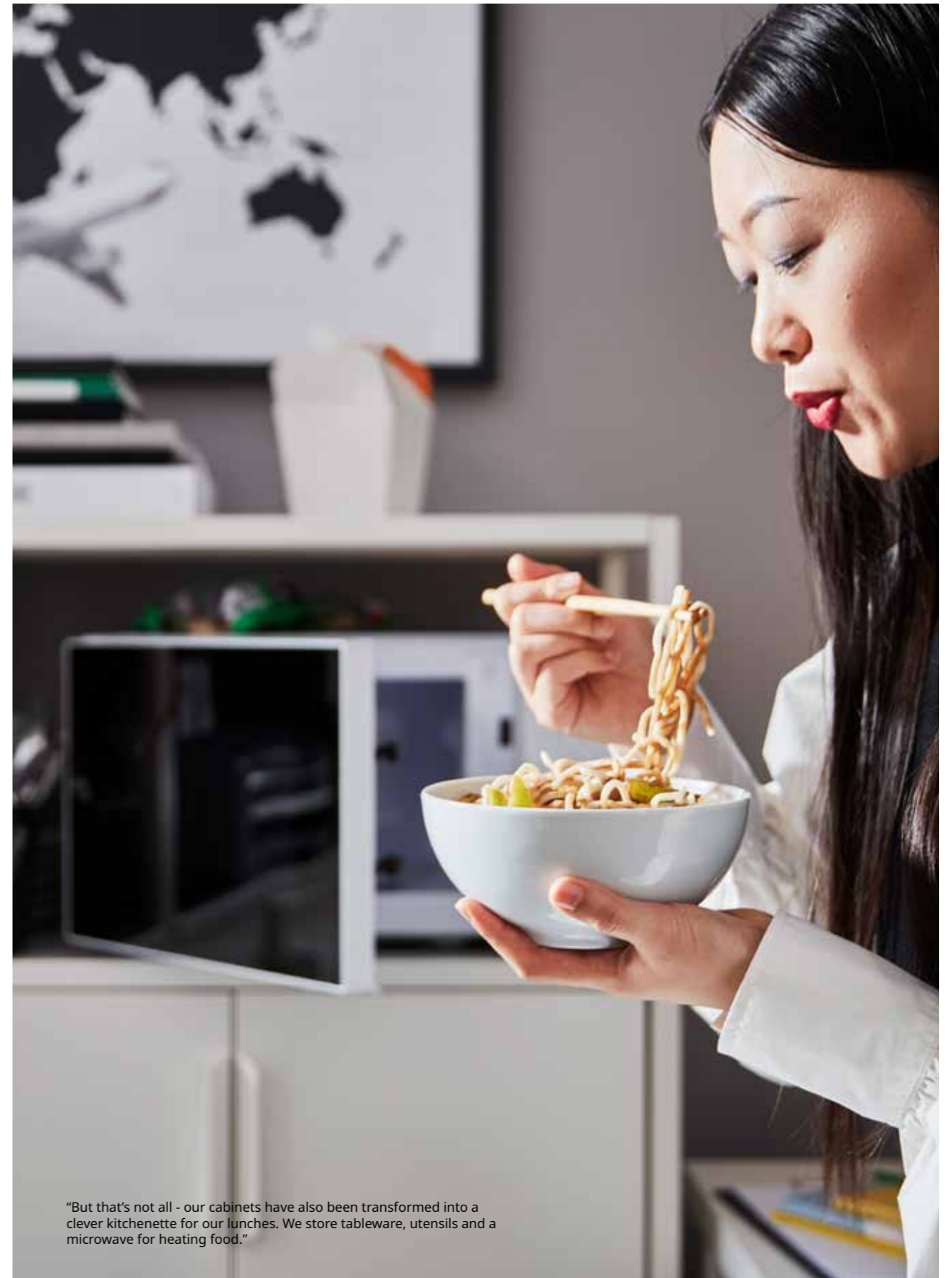

"But that's not all - our cabinets have also been transformed into a clever kitchenette for our lunches. We store tableware, utensils and a microwave for heating food."



Our office is a calm place in the heart of the city

“When we step inside our cosy accounting firm in the morning, we feel relaxed and ready to focus on our clients’ financials. Our coordinated set-up is inspired by the classic, industrial age, where the limited space must not stand in the way of comfort, performance and good results.”



"See the rounded corners? They are part of the design that creates a stylish and cohesive theme throughout the office."



"We adore the green steel cabinet. It holds everything from the bulkiest binders to the smallest paper clips – plus the splash of colour adds character to the place."



"With limited space for desk work, our office relies heavily on an additional room for meetings, group discussions and moments that require privacy. Maintaining the same style as the rest of the office creates an ideal environment for both relaxed and focused sessions."



"You can never have too much storage space. With appealing storage furniture, even the hallway can be put to good use."



"In our office, we bring together the best of two worlds. Warm wooden tones meet modern function with height-adjustable desks, sit/stand stools and clever storage."



My home is my castle... and my office

"Most importantly it is the ideal backdrop for focused and peaceful work. As a writer, I need a space where I feel relaxed and where inspiration flows as freely as morning coffee. For this purpose, I've created my own personal haven – blending form, ergonomic comfort and function all after my own taste."



"Sometimes, I invite friends or colleagues over for lunch. A blend of work and socialising boosts my energy and inspires."



"I finally found a way to manage unruly cables - it's funny how small details like this give me peace of mind."



"My favourite wall art sets the stage for a great mood and creative work."



"Despite the compact size of my office, I keep everything organised, proving that great things indeed come in small packages. This drawer unit is a perfect fit."



"My chair is my most important piece of furniture. It has all the ergonomic features I need to keep me comfy while working long hours."

Ergonomic solutions for a healthier you

Whether working in an office or at home, many of us spend the majority of the day at a desk. Sometimes, working for longer periods in a bad or uncomfortable position can cause neck and back injuries as well as other health problems.

An ergonomic workspace is one that is customised to your personal needs, allowing you to work in a comfortable and safe way. Since we are all different shapes and sizes, it is important to have

an ergonomic workspace that is adapted to your body. This not only benefits your health and well-being; it also contributes to improved focus and productivity.





Feel good and work better

We want to help you achieve an ergonomic working environment that suits you and promotes good health. This means adjusting the workspace to your needs, adopting an ergonomic position and keeping as mobile as possible. The human body is made to move, so

ideally your workspace should give you the choice of sitting, standing and leaning, allowing you to change positions often. And if you feel good at work, you will work better.

Nine steps to good ergonomics in your workspace

1. Ensure an ergonomic chair



An ergonomic office chair provides proper support for the back, neck, and arms, reducing the risk of discomfort and musculoskeletal issues. It promotes good posture, improves blood circulation and allows for greater comfort and productivity throughout the workday.

Always look for an office chair with good lumbar support and a variety of features that can be adjusted to fit your body.

Find out more about how adjustability increases your comfort on pages 88-97.

2. Enable switching between sitting leaning and standing

A height-adjustable desk allows you to change position often. Alternating between sitting and standing reduces the risk of injury and increases circulation, as well as productivity.

A sit/stand support enables a position between sitting and standing, and is ideal when you have a height-adjustable desk. It provides freedom of movement, activates and strengthens the core muscles of your body and improves blood circulation.

The top of your work surface should be elbow height and your elbows should be at a 90° angle when sitting or standing at your desk.



3. Improve the acoustic environment

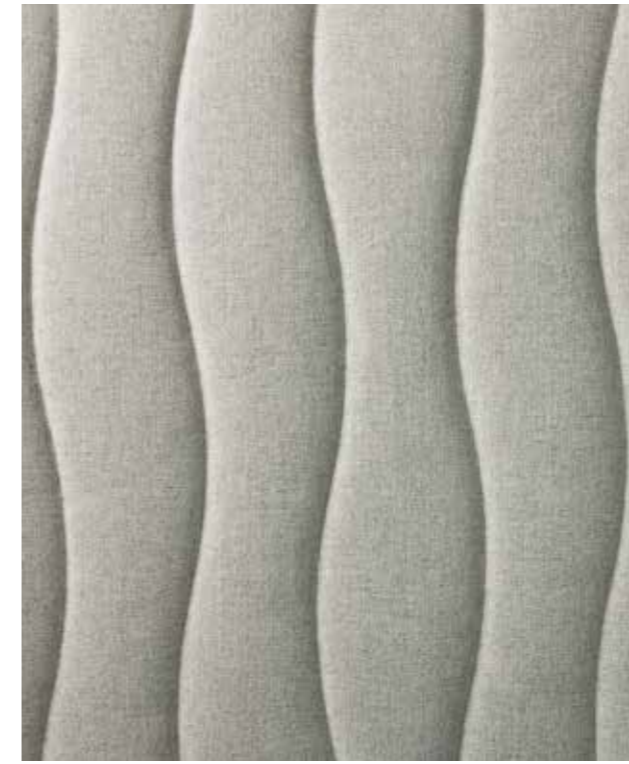

Acoustic screens absorb and reduce sounds such as laughing, ringtones and typing, creating a quieter and more focused environment. They provide privacy, minimise interruptions and contribute to a more peaceful and productive workspace. Curtains, rugs and other textiles also help absorb sound. Find out more about how to improve your acoustic environment on pages 36-47

4. Position your monitor correctly

Make sure your monitor is not placed too close. With your chair pulled in and arms stretched in front of you, you should not be able to touch the screen. The monitor should be placed directly in front of you, with the top just below eye level. A monitor stand allows you to position your screen at the right level, reducing strain on your neck and promoting better posture.



5. Hide messy cables

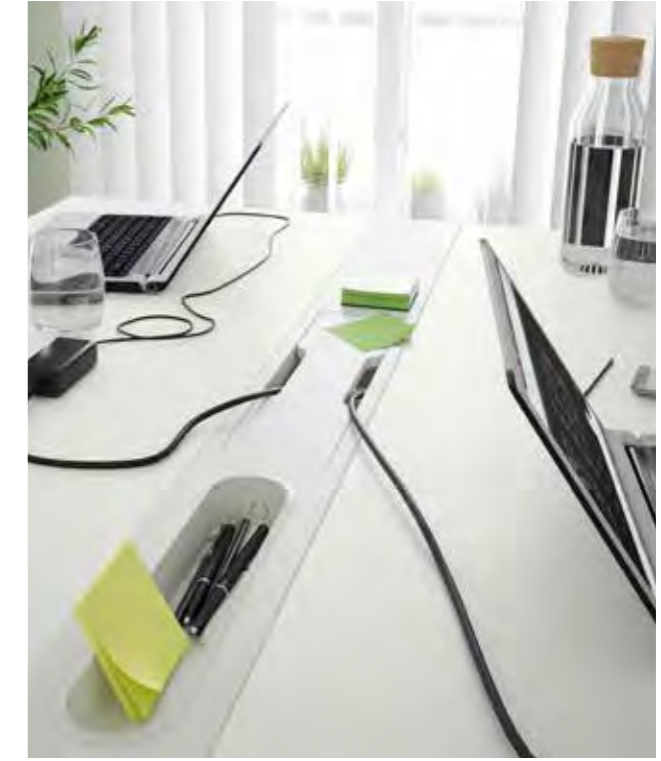

Cable management creates a clean and organised workspace, reducing visual clutter and promoting a sense of calm. It gives easier access to devices and prevents tripping hazards. Desktop-mounted solutions add convenience and prevent strains from bending and reaching for outlets under the desk.



6. Combine different types of lighting

Proper lighting reduces eye strain, enhances focus and creates a comfortable and inviting atmosphere. Usually, a combination of different types of lighting is ideal.

General lighting provides a uniform light throughout the room.

Task lighting such as a desk lamp, provides a concentrated beam of light over a limited area.

Mood lighting provides a cosy feeling and softens the contrasts between general and task lighting.

Sunlight is always welcome, but it can cause glare and reflections on your computer screen. Place your desk/ computer so the light comes in from the side. Use blinds or curtains on the windows to filter or block out daylight when you need to.



7. Relieve pressure on knees and feet



A standing mat is ideal for those who stand for long periods at their desks as the high-density foam relieves pressure on the feet, knees and back.

A footrest helps you sit in a good working position at your desk and reduces strain on your legs, back and neck.

8. Ensure ease of maintenance

A dynamic workplace may take many shapes throughout the workday as furniture is moved around for meetings or impromptu collaboration. Office furniture that is lightweight, on wheels, easy to move and park prevents muscle strain and enables seamless teamwork.



9. Invite elements of nature into your workspace



We have known for a long time that nature has a positive effect on us humans. A bike ride in the park, a walk in the woods or taking in the waves on the beach – the connection to nature makes us feel good. What happens if we can reproduce this effect indoors? Biophilic design is a concept that uses interior design to link our indoor environment with nature. Workplaces with natural light, natural ventilation and elements connected to nature have been shown to improve performance, lower stress and increase motivation.

Colour. Tone on tone colours, close to nature's own colours create a feeling of calm and harmony, helping us to relax and focus.

Material. The materials you choose, such as a warm wood veneer or a tactile material that feels soft to the touch is also a way to bring nature indoors. It is inviting, and we feel good taking it in.

Organic shapes and patterns such as those found on leaves, animals, water and sand make us think of the outside world – they feel familiar and help us to relax.

Greenery in the workspace has been shown to have a calming effect, helping to reduce stress and when we think beyond potted plants in the window, there is a lot we can do. For instance, plants can be used to create room dividers or cozy rooms-within-a-room.



Why acoustics matters

Today, many offices are designed with open floor plans that expose us to noise and visual distractions, influencing our ability to focus. Ring sounds, chattering colleagues, fingers typing away on the keyboard, screeching chairs – all these and other sounds amount to the disturbing noise levels we often experience at our workplace. Fortunately, there are ways to work around this.

Happy and healthy workspaces involve finding the right noise-reducing solutions and possibilities to create privacy. That's where our acoustic products step in, designed with your well-being in mind to enhance your comfort and productivity.





What is room acoustics?

Room acoustics is how sound travels or behaves within a room or any given space. Without elements to absorb sound or prevent sound waves from bouncing back and forth, we perceive the acoustic environment as disharmonious.

Reverberation time is the time it takes for sound to cease, depending on the size of the room and the objects and materials in the room that absorb sound. With simple measures, we can improve room acoustics and reverberation time to create quieter spaces that are more conducive to working and collaborating.

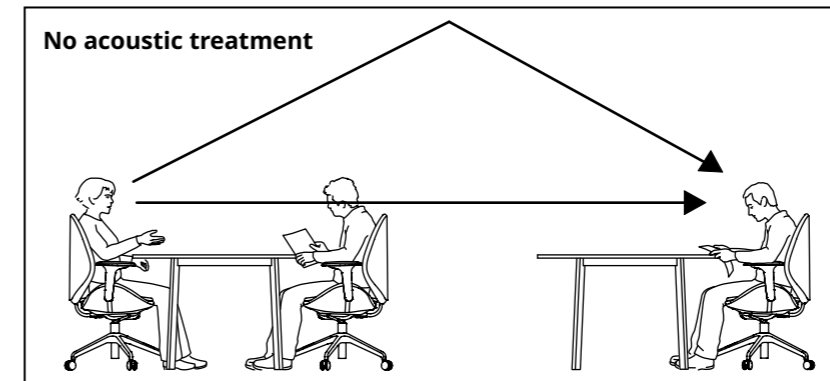

When there is nothing to block or absorb the sound, the sound waves bounce around the room making the acoustic environment disharmonious for everyone in the surroundings.

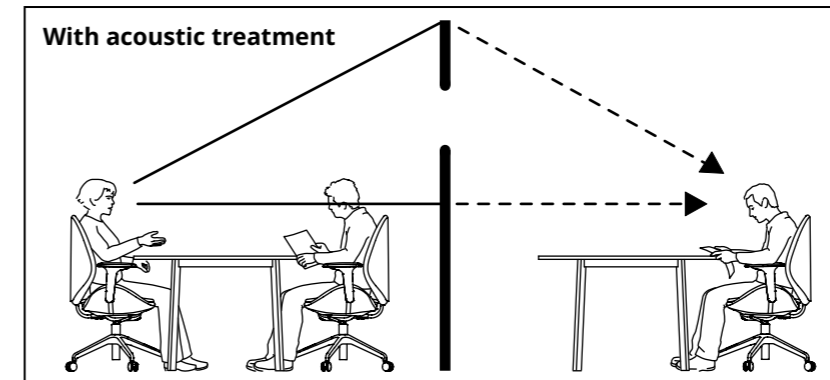

The less the sound bounces around, the shorter the reverberation time, which leads to better acoustics and speech intelligibility.

5 steps to good acoustics in the workplace

1. Work with sound absorption.



Non-porous materials like glass, MDF or concrete cause sound to reflect, creating echoes while porous materials like curtains, seat covers and rugs absorb sound. Acoustic products like desk screens and floor-standing screens also absorb sound and help to balance the presence of non-porous materials.

3. Place furniture strategically.

Voices, ring tones, footsteps and other sounds can be softened with acoustic screens and room dividers with green plants. Shelves with books can also help. If possible, prevent unwanted noise altogether by placing printers and coffee machines in separate rooms. Ensure chairs on legs are fitted with felt pads and those on castors roll on sound-absorbing material. Drawer dampers also make a big difference.

2. Block the sound.



Divide the space into separate acoustic zones using various types of barriers to prevent sound from traveling freely in an open landscape or between two workstations. Desk and floor-standing acoustic screens as well as acoustic screens on castors are ideal for this purpose.

4. Use textiles.

Curtains, rugs, plants and other porous, soft objects help absorb sound waves. Use curtains with a thick fabric and hang them a bit out from the wall/window. Furniture with soft seats and seat covers add comfort and also absorb noise.

5. Privacy is important.

Room dividers, desk screens and floor-standing screens all help to divide areas and create both visual and acoustic privacy so you can work with less distractions.



Acoustic products help create a balanced sound environment

Our acoustic products have been developed and tested together with acoustic specialists to ensure they meet sound absorbing and sound blocking requirements. Our designers put special focus on enabling fluid office spaces; and applying patterns, colours and materials

inspired by nature. The thick, quilted screens create a warm and harmonious environment while also ensuring privacy between workstations.



The magic starts on the inside. MITTZON acoustic screens are constructed with a low-density fibreboard core surrounded by a thick, wood fibre filling with excellent acoustic performance. The screens are dressed with a thick, durable fabric that is removable/machine washable. The acoustic screen on castors is 50 mm thick and the desk and floor-standing acoustic screens are 80 mm thick, filled with goodness for your ears.

The filling contains 92% renewable and recyclable wood fibre content sourced from harvested trees which are debarked and chopped into small square chips, not much bigger than postage stamps. The chips are softened with steam and milled to obtain fibres. The fibres are dried and mixed with a bonding fibre, and then melted together into sheets that are cut to size. Left-over trimming is re-used in the production so that there is no waste.



Acoustic screens on lockable castors can be used to separate desks or create a meeting area. Notes can be pinned directly onto the fabric cover.



Acoustic screens for desks are ideal for creating privacy around your workspace.



MITTZON acoustic screens

"When designing MITTZON acoustic screens, I wanted to soften the hard and often cold feel of office furniture and looked to organic shapes found in nature for inspiration. The flowy pattern on the quilted screens remind of the sand ripples formed by waves on the beach. The screens are filled with 2 layers of wood fibres and covered with a thick fabric to ensure good sound absorbency. The rounded wooden rod that comes with the floor-standing screen is a clever detail that allows you to connect two or more screens, so you can create separated work areas for collaboration."

The desk screens do a good job at defining your personal space so that you will find it easier to focus. Open workspaces can be very challenging at times – but these acoustic screens will help to create some well-needed privacy and a sense of calm."

Designer Andreas Fredriksson





MITTZON focus workstation

"Welcome to my bubble! Have you ever felt the need to retreat into your own cocoon or place where you can work undisturbed? I know I have. When I designed MITTZON focus workstation, I wanted to create a private workspace that you can claim as your own for a while - whether it be in the office, lobby or hotel lounge. I love the playful design and hope it wakens people's curiosity. Everyone deserves a comfy cocoon where they can focus - away from all the buzz."

Designer Marcus Arvonen



Acoustics in open work areas

The office layout strongly affects the sound environment and today, many offices are designed with open and flexible floor plans that expose us to noise and visual distractions. Luckily, these distractions can be reduced with good planning and a mix of solutions that absorb and block sound. Here are some things to consider:

Secure a good general noise level. Ensure good sound-absorbing elements on the ceilings and walls.

Divide the space by activity. If possible, place printers and coffee machines in separate areas/rooms. Plan open areas, such as entrance or lounge far from focus areas. Frames on castors with shelves, plants or whiteboard/noticeboard screens can be used to divide the space to define the different areas while also blocking the sound.

Divide the workspaces. Desk or floor-standing acoustic screens help create personal workspaces with visual privacy and effectively absorb sound.

Add elements to dampen chatter. When sound-absorbing elements are in place, colleagues can talk without raising their voices – which in turn keeps noise levels down. Textiles and sound absorbing screens help.

Hallways are many times over-looked in terms of acoustics. NÄVERHÄGG sound absorbing panels and rugs help to create a good balance.

Entrance/Reception/Coat room are often the source of noise coming from greeting visitors and colleagues before meetings. Acoustic screens on castors, plants and shelves enhance the environment and help to block and absorb sound.

Meeting rooms are generally closed and do not require sound blocking elements. Rather, it is important to use sound absorbing elements to prevent sound from bouncing around – but not too much as this will make voices muffled. NÄVERHÄGG sound absorbing panels, curtains and rugs help to create a good balance. Ensure flatwoven rugs for easy movement of conference chairs

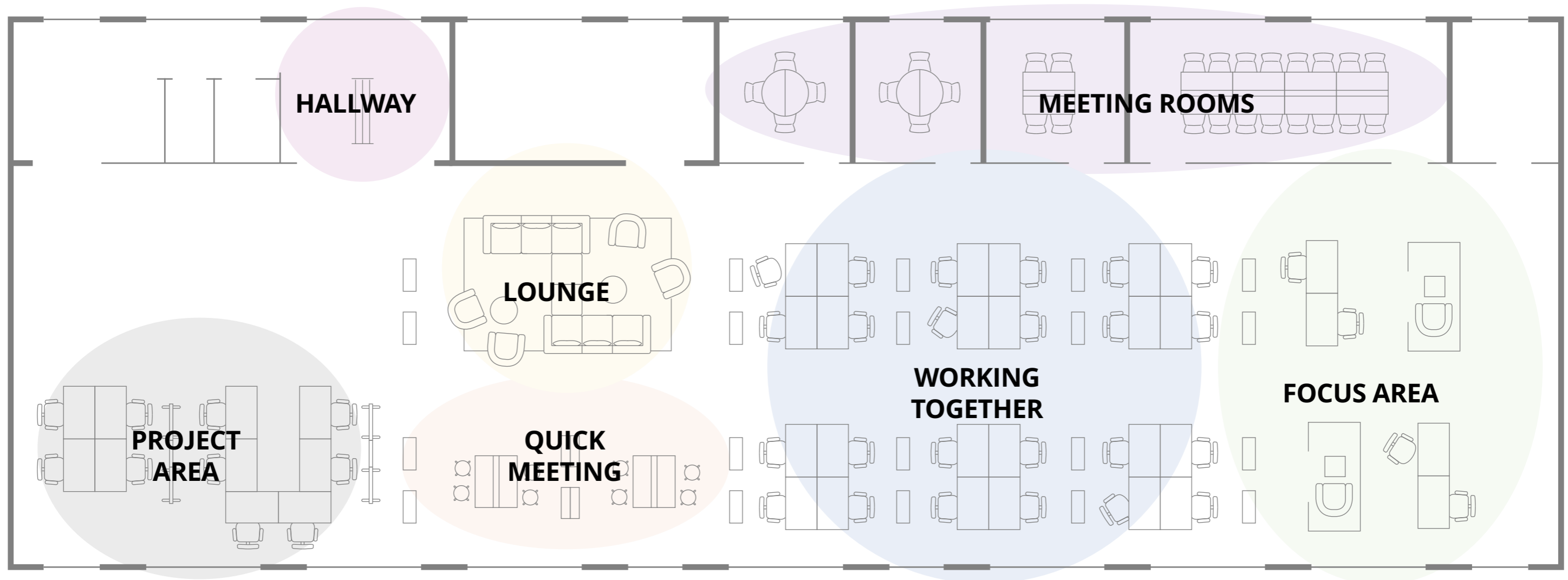

Meeting spaces in the office

Digital, physical, long, short, formal or informal – every day we meet our colleagues, customers and partners in many different ways and modern workplaces need to provide a variety of environments designed to support efficiency and productivity through our comfort and well-being.





Formal meeting rooms need to be supplemented with a variety of flexible meeting spaces for different purposes.

High tables can be placed together and used while sitting or standing, helping to keep the energy up during workshops.



Flexible elements like acoustic screens, frames on wheels, storage units, plants or textiles help create rooms within rooms.

Open or semi-open environments are often conducive to teamwork, project meetings or spontaneous collaboration. They allow departments to interact more freely and contribute to an inclusive workplace culture. It also opens up the possibility to adapt the space after changing needs.

Different zones for different focus needs

When planning the office, consider the different environments and how they are placed in relation to each other. A good idea is to divide the space into different focus needs. For instance, a zone for working totally

undisturbed, a zone where you can work focused but also discuss things with nearby colleagues, and zones for collaboration, activity and movement.



MITTZON frames on castors with whiteboard/pinboard provide a sense of privacy.



High tables combined with sit/stand supports enable participants to be more active, stand up and join in discussions.



A whiteboard/pinboard allows you to write or pin up all your great ideas.

In creative meetings and brainstorming sessions, it is important to be able to move freely in the environment to keep up the momentum and pace. This is also true for spontaneous meetings where the right setting can help strengthen cooperation and problem solving. For longer or more formal meetings, it is a good idea to arrange a closed room for privacy with comfortable seating.



Flexibility in the workspace

Change is part of the everyday reality in any workplace. Whether it be a re-organisation, a change of routines or new hybrid working patterns. To ensure that the workplace serves many types of functional needs over time while also promoting a sense of balance and well-being – the work environment must be able to adapt to the changing needs both in the short-term and in the long-term.





Day-to-day flexibility

Furniture gets moved around in the workplace all the time. Sometimes it is a matter of moving closer to a colleague to go through a presentation, or it could be about adding extra tables or chairs to a meeting room. For day-to-day flexibility, it is good to have furniture with castors that are easy to move to where they are needed, and just as easy to move back, fold and stack

when not in use. Flexibility is also supported with multi-functional products such as MITTSON frames with castors to create mobile green walls or screens with whiteboards, that allow you to write key notes, wherever the meeting takes place. MITTSON laptop table on castors allows you to work where it suits you today – and you can easily change position from sitting to standing.



A height-adjustable laptop table with castors is ideal for presentations or to create a small workspace in the reception.



A high conference table for sitting or standing creates a perfect spot for spontaneous, ad hoc meetings.



Roll the table out and let the meeting begin. When it's time for a new activity, simply fold it and roll it back.



Time for refreshments? TROTEN trolley with castors is easy to bring to meetings or workshops.



Flexibility on demand

From time to time, functional needs may change – but only for shorter periods. A new project may require a dedicated area where a team can collaborate without disturbing others. Our MITTZON, IDÅSEN or TROTTEEN desks can be combined and moved around to create

different solutions for working individually or together. You can fulfil your changing needs while also maintaining a balanced and uniform expression throughout the office.



A space-wise solution with individual workplaces that share the same storage in between.



A workshop area surrounded by storage for privacy.



Your own space for focusing in a large open floor plan.

TROTTEEN system adjusts to one or many co-workers. It's modular, stylish design follows your changing needs with multipurpose furniture and practical units you can add on.



Flexibility over many years

The way you furnish your office today, may not be the best solution for tomorrow. Long-term flexibility is about making wise choices from the start so you can seamlessly scale up, scale down, reshuffle and re-organize your interior in a cost-efficient way to meet your functional needs, while keeping a uniform overall impression.

Choosing office furniture of good quality, that is tested and guaranteed, will endure many moves and ensure low life-cycle costs. When you also choose office furni-

ture that is part of a series, it is easier to add, remove or rearrange furniture and still have a coordinated expression.

Check how our MITTZON, TROTTEEN and IDÅSEN series, designed with flexibility, quality and ergonomic comfort in mind can help you develop an office interior customized to your needs – a harmonious solution that is economically sustainable and contributes to everyone's well-being over many years.



Office desks

Whether you're setting up a home office, revamping your workspace or furnishing a corporate environment, our office desks provide a perfect blend of aesthetics, ergonomic comfort and functionality. Choose between several sit/stand solutions to promote a healthy posture and enjoy a clutter-free workspace with clever integrated cable management solutions. If you are looking for a sleek, modern design or a more timeless feel – we've got you covered. Our range offers a wide variety of finishes and sizes – all which are durable, crafted for longevity and backed by generous guarantees.



A perfect place to focus

What is most important for you? Price, function, ergonomics, style? With our range of different tabletops, bases and finishes, you can create a unique workplace that matches your space, needs and preferences. Our desks are built into systems so that you can easily furnish a flexible office with different types of desks and create a uniform aesthetic expression. Each system includes height adjustable alternatives so that you can vary positions between sitting and standing, to make sure that your body is energised and you keep full focus on your work.



10

As confirmation of the high quality, our office desks have been tested and approved for office use and are backed by a 10-year guarantee.

MITTZON desks

MITTZON desk series is all about function, quality and comfort contributing to your well-being and ability to focus. The durable tabletops are available in several sizes, in your choice of low-gloss white or one of 4 different wood veneers with tactile feel. Combine the tops with a white or black height-adjustable (manual or electric) steel underframe that lets you vary between sitting and standing throughout the day – your body will thank you.



TROTTEEN office desks

TROTTEEN desks come in different sizes to suit the smallest corners and larger open spaces. Choose between A-shaped legs or a manual height-adjustable underframe to enable changing positions while working. Combine white or beige tops with white or black underframes. The desks are dimensioned for a perfect fit with TROTTEEN storage, so you can scale up your solution and maintain the same unified expression as your needs grow.



IDÅSEN desks

Industry-inspired IDÅSEN desks offer a beautiful veneer surface that is durable, stain resistant and easy to clean. Choose between manual or electric height adjustment and enjoy the practical cable management solution underneath the desk. IDÅSEN desks coordinate perfectly with storage solutions in the same series.



Key features

MITTZON desks



Choose between low-gloss white, walnut, oak, birch or black-stained ash veneer. All tops come complete with durable edging in a matching finish.



The included cable management tray is width adjustable and accessible from above and the sides.



The plug-in module at the back of the desk allows you to charge your equipment without having to crawl under the desk. MITTZON plug-in module comes in the same colours as the underframes. It has a small compartment perfectly sized for KOPPLA cable socket (sold separately), or to store smaller items such as pens or post-it notes.



MITTZON acoustic screens award privacy and are perfectly sized to fit the desks.

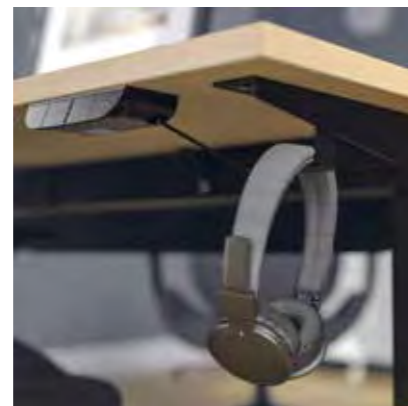

The underframe allows plenty of space to move your chair and legs freely under the table, whether sitting or standing. It includes 2 hooks for hanging headphones, bags or jackets.

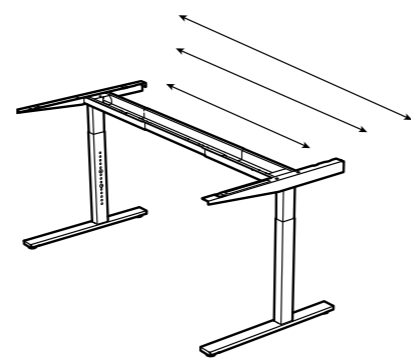

Width-adjustable underframe can be paired with MITTZON tabletops widths 120, 140 and 160 cm allowing you to change to a bigger or smaller desk if needed, using the same underframe.

MITTZON height-adjustable desks



The hand control for the electric sit/stand underframe has 2 memory settings for convenient adjustment.

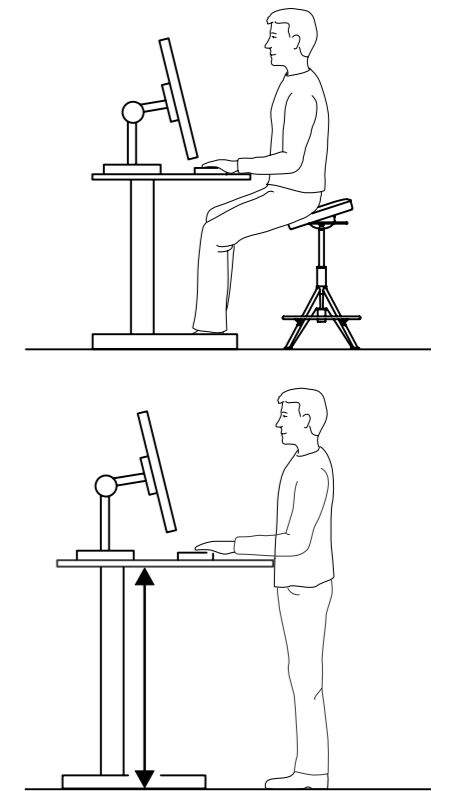

Changing position between sitting and standing regularly improves your circulation and delivers more oxygen to the brain, helping to increase energy levels, attentiveness and productivity.

MITTZON mechanical desks

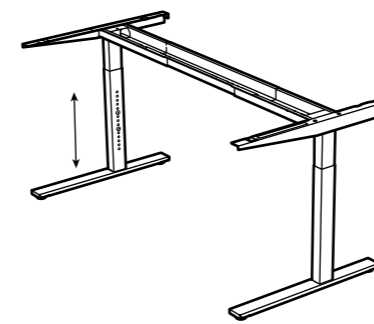

Choose the most comfortable and ergonomic work height for your body when you assemble the desk. Reassembly of legs required to change the desk height.



MITTZON desk pairs perfectly with GRÖNFJÄLL office chair, helping to encourage healthy habits and engagement.

How to build MITTZON desks

01

Choose your favourite top.

Do you prefer low-gloss white or a more natural look with walnut, oak, birch or black stained ash veneer?

02

Start with the size.

You can choose between widths 120, 140 or 160 cm all which come in depths 48 or 68 cm.

03

Select underframe.

Choose between black or white and whether you want to choose the height of your desk when assembling it or an electric sit/stand desk – either way the coordinated cable management is included.

04

Gear up for easy plug in.

When you add MITTZON plug-in module to your combination, the desk depth increases by 12 cm to either 60 or 80 cm. The modules are available in black or white to coordinate with the underframes.

05

Fancy anything else?

Complete your desk solution with STUBBERGET monitor arm in black or white and easy-mount MITTZON acoustic screens.

MITTZON height-adjustable desks. 120×80 cm.

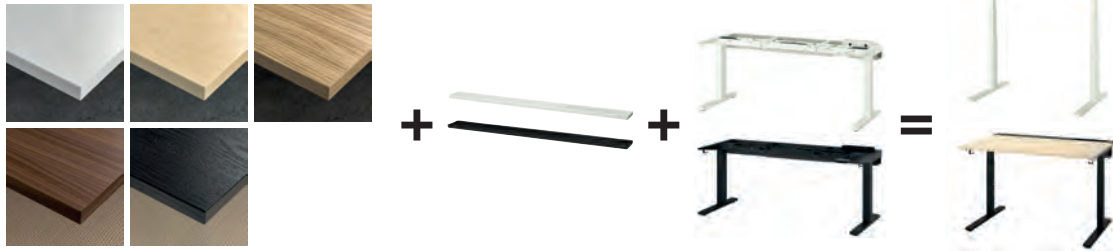

MITTZON height-adjustable desk. 140×60 cm or 140×80 cm.



MITTZON height-adjustable desk. 160×80 cm.



Mechanical desk. 120×80 cm, 140×60 and 140×80 cm and 160×80 cm.



Key features

TROTTEEN desks with a crank



TROTTEEN sit/stand desks come in sizes 120×70 cm and 160×80 cm. The generous depths allow a roomy work surface and you can sit at a comfortable distance from the computer monitor without straining your eyes.



You can easily crank the handle to adjust the desk height between 70-120 cm to get the best position for both sitting and standing.



The crank handle can be mounted on the left or right side – whatever is most convenient for you. It slides in under the tabletop when not in use for a clean, uncluttered look.



Adjustable feet make the table stand steady also on uneven floors.

TROTTEEN desks



The desks are lightweight and easy to move around for meetings or collaboration projects. A-shaped legs make it possible to combine the tables in many creative ways and you can fit a lot of chairs around it.



You can hang essentials like your bag or headphones within easy reach on the two hooks on the sides of the tables.

IDÅSEN sit/stand desks

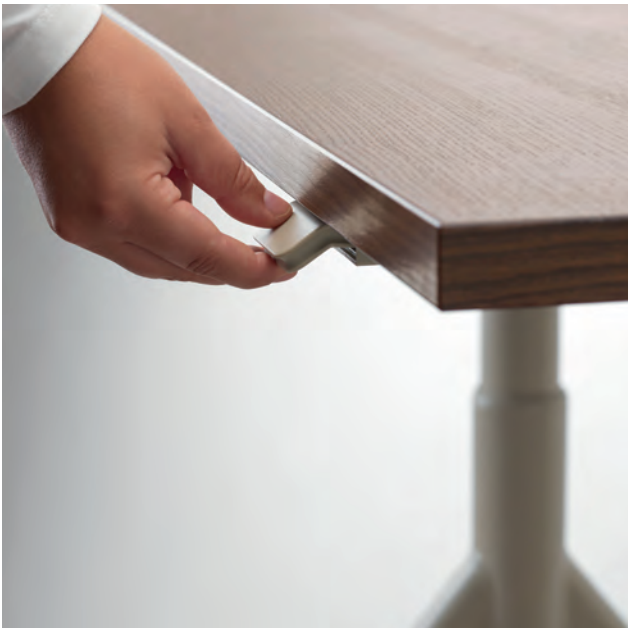

Change smoothly between sitting and standing using the 2 buttons for electronic height adjustment.



You can also adjust the height of your desk using an app.

IDÅSEN desks



The veneer surface with beautiful wooden pattern is durable, stain resistant and easy to keep clean.



It's easy to keep your desk neat and tidy with the cable management net under the tabletop.

MITTZON

Desk sit/stand 120×80 cm

An ideal size for smaller office spaces. MITTZON sit/stand desk with tactile design elevates your well-being and possibility to focus. Backed by a 10-year guarantee.



W120×D80 cm.

Max height 126 cm, min height 62 cm. Max load 80 kg.

Birch veneer/white	195.139.53
Black stained ash veneer/white	995.277.72
Oak veneer/white	695.277.97
Walnut veneer/white	595.279.29
White	995.275.69
Birch veneer/black	095.277.24
Black stained ash veneer/black	995.277.48
Oak veneer/black	495.277.84
Walnut veneer/black	095.279.03
White/black	595.275.52

Desk sit/stand 140×60 cm

An ideal size for small to medium-size office spaces. MITTZON sit/stand desk with tactile design elevates your well-being and possibility to focus. Backed by a 10-year guarantee.



W140×D60 cm.

Max height 126 cm, min height 62 cm. Max load 80 kg

Birch veneer/white	895.282.39
Black stained ash veneer/white	495.282.84
Oak veneer/white	695.283.15
Walnut veneer/white	695.283.39
White	695.281.84
Birch veneer/black	595.282.26
Black stained ash veneer/black	095.282.57
Oak veneer/black	295.282.99
Walnut veneer/black	395.283.26
White/black	795.281.45



Desk sit/stand 140×80 cm

An ideal size for small to medium-size office spaces. MITTZON sit/stand desk with tactile design elevates your well-being and possibility to focus. Backed by a 10-year guarantee.



W140×D80 cm.

Max height 126 cm, min height 62 cm. Max load 80 kg.

Birch veneer/white	195.286.19
Black stained ash veneer/white	495.289.53
Oak veneer/white	695.289.71
Walnut veneer/white	795.290.03
White	195.285.63
Birch veneer/black	495.285.85
Black stained ash veneer/black	795.289.42
Oak veneer/black	695.139.55
Walnut veneer/black	195.289.78
White/black	695.285.51



MITTZON

Desk sit/stand 160×80 cm

Provides generous space for screen(s) and desk organisers. MITTZON sit/stand desk with tactile design elevates your well-being and possibility to focus. Backed by a 10-year guarantee.



W160×D80 cm.

Max height 126 cm, min height 62 cm. Max load 80 kg.

Birch veneer/white	495.301.83
Black stained ash veneer/white	395.302.30
Oak veneer/white	995.302.65
Walnut veneer/white	295.303.44
White	595.299.66
Birch veneer/black	795.301.72
Black stained ash veneer/black	495.302.01
Oak veneer/black	295.302.35
Walnut veneer/black	995.302.70
White/black	295.298.83

Desk 120×80 cm

An ideal size for smaller office spaces. MITZON height-selectable desk with tactile design elevates your well-being and possibility to focus. Backed by a 10-year guarantee.



W120×D80 cm.

Max height 85 cm, min. height 65 cm. Max. load 50 kg.

Birch veneer/white	995.260.46
Black stained ash veneer/white	095.260.84
Oak veneer/white	295.260.97
Walnut veneer/white	895.261.03
White	095.260.36
Birch veneer/black	795.260.33
Black stained ash veneer/black	295.260.40
Oak veneer/black	995.260.70
Walnut veneer/black	995.260.94
White/black	895.260.99

MITTZON

Desk 140×60 cm.

An ideal size for small to medium-size office spaces. MITTZON height-selectable desk with tactile design elevates your well-being and possibility to focus. Backed by a 10-year guarantee.



W140×D60 cm.

Max height 85 cm, min. height 65 cm. Max. load 50 kg

Birch veneer/white	295.280.39
Black stained ash veneer/white	795.280.46
Oak veneer/white	395.280.53
Walnut veneer/white	495.280.57
White	995.139.54
Birch veneer/black	695.280.37
Black stained ash veneer/black	295.280.44
Oak veneer/black	795.280.51
Walnut veneer/black	895.280.55
White/black	995.279.46

Desk 140×80 cm.

An ideal size for small to medium-size office spaces. MITTZON height-selectable desk with tactile design elevates your well-being and possibility to focus. Backed by a 10-year guarantee



W140×D80 cm.

Max height 85 cm, min. height 65 cm. Max. load 50 kg.

Birch veneer/white	495.281.18
Black stained ash veneer/white	495.281.23
Oak veneer/white	995.281.30
Walnut veneer/white	495.281.42
White	595.281.13
Birch veneer/black	895.281.16
Black stained ash veneer/black	895.281.21
Oak veneer/black	395.281.28
Walnut veneer/black	895.281.40
White/black	995.281.11

Desk 160×80 cm.

Provides generous space for screen(s) and desk organisers. MITTZON height-selectable desk with tactile design elevates your well-being and possibility to focus. Backed by a 10-year guarantee.



W160×D80 cm.

Max height 85 cm, min. height 65 cm. Max. load 50 kg.

Birch veneer/white	695.291.12
Black stained ash veneer/white	995.291.15
Oak veneer/white	195.291.24
Walnut veneer/white	695.291.26
White	095.290.87
Birch veneer/black	895.291.06
Black stained ash veneer/black	395.291.18
Oak veneer/black	595.291.22
Walnut veneer/black	495.139.56
White/black	995.290.83

Desk sit/stand 120×70 cm

Changing positions from sitting to standing is good for you, and the crank handle allows you to work your arms while adjusting the height. Moving your body makes you both feel and work better.



W120×D70 cm.
Max. height 122 cm, min. height 72 cm. Max. load 50 kg.

Beige/white	894.341.27
White	994.295.78
Beige/anthracite	794.295.84
White/anthracite	394.295.81

Desk sit/stand 160×80 cm

Changing positions from sitting to standing is good for you, and the crank handle allows you to work your arms while adjusting the height. Moving your body makes you both feel and work better.



W160×D80 cm.
Max. height 122 cm, min. height 72 cm. Max. load 50 kg.

Beige/white	294.341.30
White	794.296.02
Beige/anthracite	194.295.96
White/anthracite	594.295.99

Desk 140×80 cm

This sturdy desk is guaranteed to outlast years of coffee and hard work. You get a generous work surface and a clever solution to keep cables in place underneath.



W140×D80×H75 cm.
Max. load 50 kg.

Beige/white	994.342.59
White	594.295.56
Beige/anthracite	894.295.50
White/anthracite	294.295.53

Desk 160×80 cm

This sturdy desk is guaranteed to outlast years of coffee and hard work. You get a generous work surface and a clever solution to keep cables in place underneath.



W160×D80×H75 cm.
Max. load 50 kg.

Beige/white	994.342.59
White	594.295.56
Beige/anthracite	894.295.50
White/anthracite	294.295.53



IDÅSEN

Desk sit/stand 120×70 cm

This sturdy desk is guaranteed to outlast years of coffee and hard work. You get a generous work surface and a clever solution to keep cables in place underneath.



W120×D70 cm.

Max. height 127 cm, min. height 63 cm. Max. load 70 kg.

Brown/beige

192.809.15

Desk 120×70 cm

This sturdy desk is guaranteed to outlast years of coffee and hard work. You get a generous work surface and a clever solution to keep cables in place underneath.



W120×D70 cm.

Max height 79 cm, min. height 65 cm. Max. load 70 kg.

Brown/beige

192.809.15

Desk 160×80 cm

This sturdy desk is guaranteed to outlast years of coffee and hard work. You get a generous work surface and a clever solution to keep cables in place underneath.



W160×D80 cm.

Max height 79 cm, min. height 65 cm. Max. load 70 kg.

Brown/beige

892.810.30

RODULF

Desk sit/stand 140×80 cm

It's good for both body and mind if you can vary between standing and sitting during working hours. This desk is designed for office use and you electrically change the height with the touch of a button.



W140×D80 cm.

Max. height 117 cm, min. height 70 cm. Max. load 70 kg.

Grey/white

993.261.70



Complementary ergonomic products

At the core of any ergonomic workspace are the desk and the chair. These pieces set the stage for a harmonious work experience, allowing you to adjust, align, and position yourself for optimal comfort and efficiency. When you also include complementary ergonomic products, you bring comfort and efficiency to new levels.

The IKEA range includes a wide range of clever solutions designed to support your physical interaction with your work environment. Cushioning standing mats, footrests, monitor stands - by integrating products like these into your workspace, you are embracing the full spectrum of ergonomic solutions to create an even healthier, comfier and more productive environment.

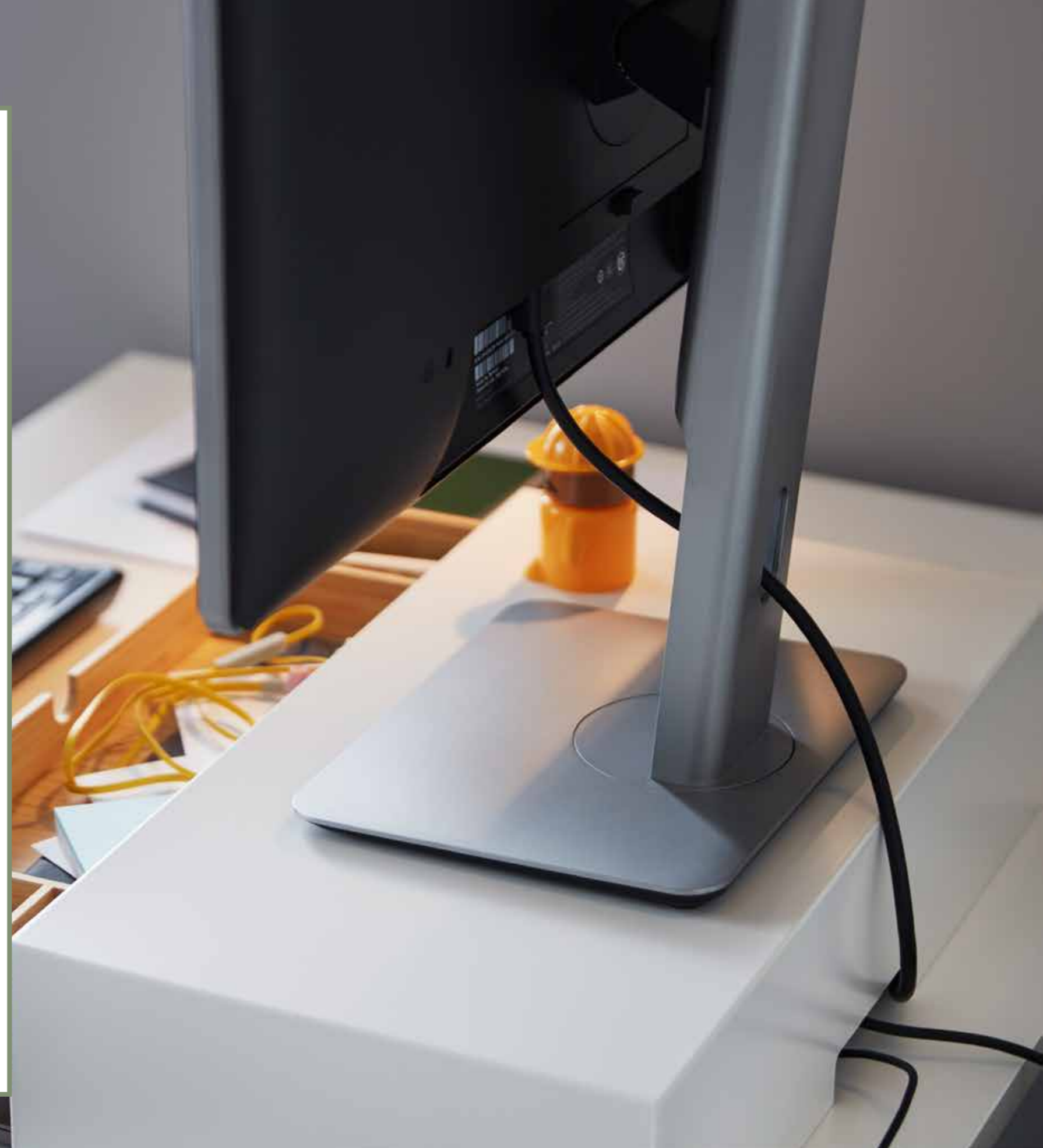

Key features

Complementary ergonomic products



ELLOVEN monitor stand with drawer places the monitor at the right height to relieve strain on your neck and shoulders. The stand has an opening in the back for tidy cable management.



The drawer with compartment helps keep pens, notepads and USB sticks organised. The space under the bamboo drawer is perfect for storing the keyboard.



You can use VATTENKAR laptop/monitor stand in different ways; as a fixed shelf for storing small things and a keyboard; as 2 separate supports or as 1 higher support.



STENERIK laptop/monitor stand raises your laptop and gives you a better posture while allowing air to circulate to keep the computer cool. Made of layer-glued wood in a timeless style.



DUBBLA laptop stand is height-adjustable between 18-41 cm. Simply hold the handle and pull up/push down the top panel until you find the best ergonomic position for standing or sitting.



ÖJULF laptop support with cushion and washable cover allows for a more fluid lifestyle – making your workday comfortable, wherever you are.



DAGOTTO footrest helps you sit in a good working position at your desk and reduces strain on your legs, back and neck.



FREIVID standing mat is ideal for those who stand for long periods at their desks as the high-density foam relieves pressure on the feet, knees and back.



A drill-free desktop shelf that is handy for plants or smaller desk items. Adjustable in 3 positions.

Small details can make a big difference when it comes to your well-being. Ergonomic enhancers like monitor stands, laptop supports, footrest and anti-fatigue standing mats help keep you comfortable and energised throughout the workday.



ELLOVEN monitor stand with drawer. Placing a monitor at the right height relieves strain on your back and shoulders. This monitor stand takes up little space on your desk and provides practical storage to help keep your workspace tidy.

Anthracite	004.851.01
White	504.747.70



VATTENKAR laptop/monitor stand, 52×26 cm. Use this stand as a fixed shelf or as 2 separate supports or as 1 higher support.

Birch	805.415.65
-------	------------



STENERIK laptop support. This stand raises your screen, giving you a better posture when you work. Layer-glued wood design, shaped to allow air to circulate and prevent overheating.

	305.640.12
--	------------



DUBBLA laptop stand, 60×40 cm. Use this stand on your desk to switch between sitting and standing working positions in seconds. A smart ergonomic solution that reduces stress on your shoulders and back.

White	805.347.01
-------	------------



ÖJULF laptop support, 52×38 cm. This cushioned laptop support with washable cover allows for a more fluid lifestyle – making your workday comfortable, wherever you are.

Dark grey	605.563.22
-----------	------------



VATTENKAR desktop shelf, 49×15 cm. A drill-free solution that can be placed against a wall or between two desks as a divider. Adjustable in 3 positions.

White	205.415.68
Black	405.415.72

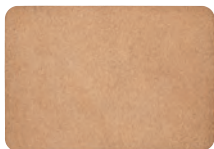

SUSIG desk pad, 45×65 cm. This cork desk pad protects your desk and dampens sounds while adding a warm and natural touch to your workspace.

Cork	904.574.86
------	------------



DAGOTTO footrest. Adjust the platform with your foot to enjoy a comfortable angle that allows you to sit relaxed at the desk. The rubber on the underside protects the floor and keeps the footrest in place.

Black	402.409.89
-------	------------



FREIVID stand mat. If you often stand at a desk while working, then this mat can come to the rescue. It is filled with foam that relieves pressure on the feet, knees and back. Washable cover with anti-slip material on the underside.

Diseröd grey-green	005.567.73
--------------------	------------

Office chairs

All our office chairs are ergonomic and designed to support your well-being. This means they have good lumbar support and can be adjusted to suit your body and individual needs. Add to this, proper cushioning and breathable materials, and you are all set to work for longer periods with less fatigue and better focus.



Key features

A well-designed ergonomic office chair can solve a number of problems related to posture, comfort, and overall health:



It supports the natural curve of your spine and promotes good posture. This can prevent common issues like slouching and hunching over your desk. The chair should have adjustable features like seat height, seat depth, backrest tilt, and armrest height to fit your body dimensions.



By providing proper support for your lower back, an ergonomic office chair can also help reduce or prevent back pain. This is particularly important for people who spend long hours sitting.



Many ergonomic office chairs include a headrest, which can support your neck and prevent strain when working for long periods. This can reduce the risk of developing neck problems and associated issues like headaches.



Ergonomic office chairs have a synchronized tilt mechanism which allows the chair to move with you. This improves circulation and keeps energy levels up.

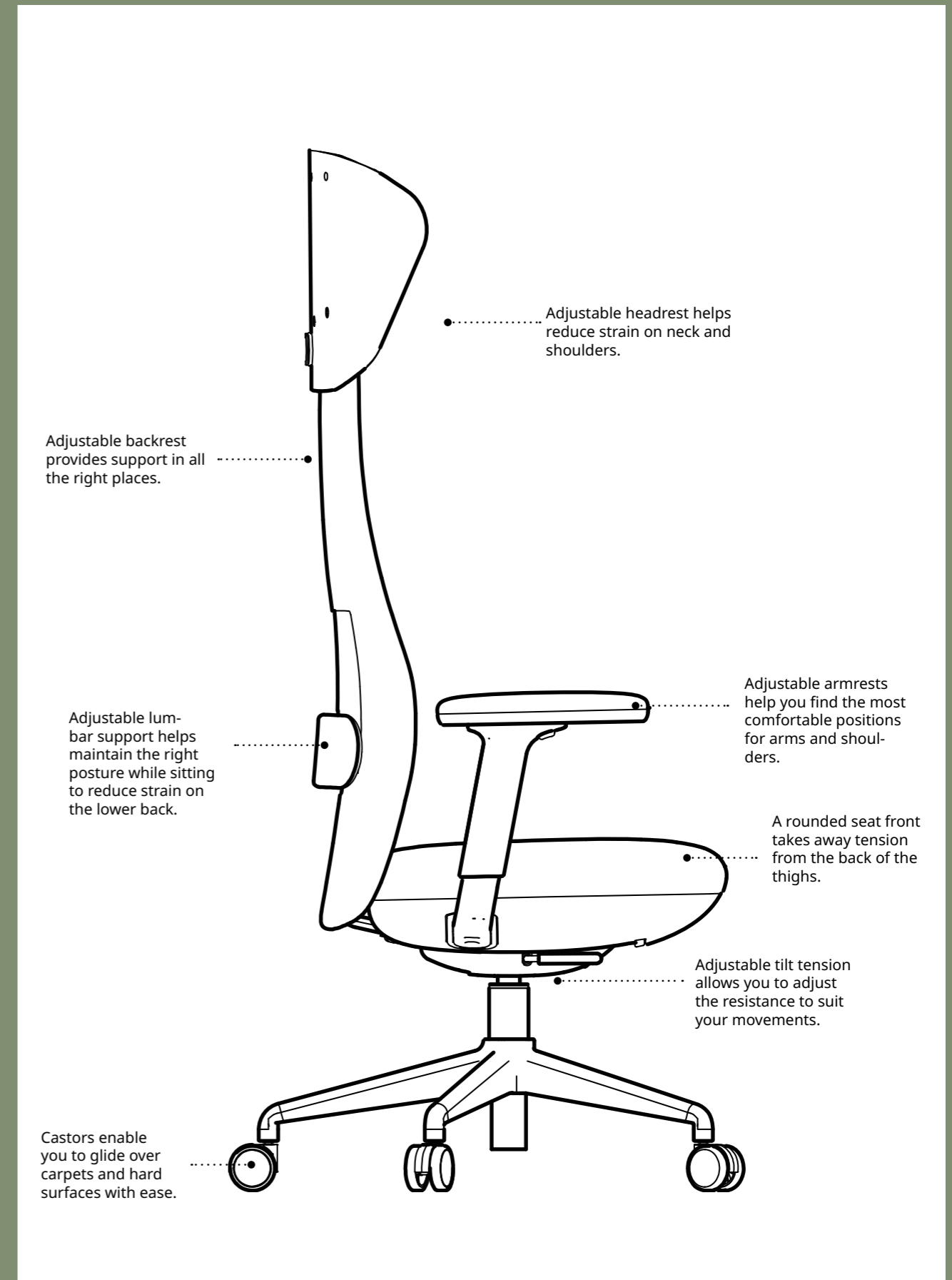

How to choose an ergonomic office chair

If there is one item that deserves special attention when you choose it for your workplace, it is your office chair. Beyond the aesthetics, there are features that can significantly impact your comfort, health and productivity. That is why it is essential to choose a chair that fits your body and work style, and to adjust it properly for maximum benefit. Here are some things to consider.

01

How many hours do you sit during the day?

The more hours you sit down, the better chair you will need. To make it easier for you to find a chair that suits your needs, we've divided the range into three recommended solutions:

Basic: If you rarely sit down during your work day, you can do well with a simpler chair with basic features such as height adjustability.

Occasional: If you sit down for short periods during the day, you will also need lumbar support, high back rest, automatic or adjustable tilt tension.

Full working day: If you spend most of your working day sitting down, you need an ergonomic chair with good adjustment possibilities.

02

Choose the mechanism that allows the right kind of movement.

Manual tilt tension

Allows you to adjust the resistance to suit your movements and weight.

Automatic tilt tension

Your body weight determines how much resistance the backrest offers.

Tilt lock

Allows you to lock the tilt in different positions.

Synchronised tilt mechanism

Allows the chair to move with you. The backrest moves more than the seat when you lean back, so torso/hips open up. This improves circulation and keeps energy levels up.

03

Does the chair tick these boxes?

Adjustability

Look for a chair with a variety of adjustable features. The more you can adjust the chair to fit your body, the better. Make sure to use all the functions of the chair and adjust it at regular intervals, to avoid a static sitting position.

Lumbar support

Good lumbar support is crucial for preventing back pain. The backrest should support the natural curve of your lower back.

Seat material

The seat and back should have enough padding to be comfortable for long periods of sitting. Breathable materials such as mesh allow air to pass through, and is a good choice if you tend to feel hot. Some chairs are made with a cooling effect material, also suitable for this purpose.

Swivel and mobility

The chair should easily rotate so you can reach different areas of your desk without straining. Castors allow easy movement around your workspace.

Stability

A five-point base reduces the risk of tipping over when leaning or moving in the chair.

Size

The chair should fit your body size. You should be able to sit with your feet flat on the floor, your knees at a 90° angle, and your back against the backrest. There should also be 5-8 cm between the back of your knees and the seat of the chair.

04

Look for these ergonomic features



Height adjustable seat; for a comfortable sitting posture regardless of body height.



2D adjustable armrests; height and width adjustable armrests enable a relaxed position for arms and shoulders and reduce the risk of tension.



Height-adjustable backrest; provides support in all the right places and helps your body to maintain a naturally good posture.



3D adjustable armrests; height, width, and depth adjustable armrest helps you find the most comfortable and supportive position for the arms and shoulders, leading to improved posture and reduced fatigue.



Adjustable lumbar support; helps maintain the correct posture while sitting which reduces strain on muscles on your lower back.



Manual tilt tension; allows you to adjust the resistance to suit your movements and weight.



Adjustable seat depth; easy to adapt for increased support to your thighs and back.



Automatic tilt tension; your body weight determines how much resistance the backrest offers.



Adjustable headrest depth; adjust the depth position of the headrest to fit your needs, reducing strain on the neck and shoulders.



Synchronised tilt mechanism; allows the chair to move with you. The backrest moves more than the seat when you lean back, so torso/hips open up. This improves circulation and keeps energy levels up.



Adjustable tilting neck support; adjusting the headrest angle for optimal support and comfort reduces neck muscle strain and prevents discomfort during prolonged sitting.



Tilt lock; allows you to lock the tilt in the upright, the lowest position and different positions in-between.



Adjustable headrest height; allows for proper alignment of the head and neck, reducing the risk of discomfort from prolonged sitting.



Removable washable cover, seat; easy to keep clean and fresh, as you can take it off and machine-wash it.









Armrests; provide support for the upper part of your forearms and reduce strain on the back and shoulders.



Removable washable cover, backrest and seat. The cover is easy to keep clean and fresh, as you can take it off and machine-wash it.

Office chairs

Ergonomic features

	Adjustable seat height	Adjustable seat depth	Lumbar support	Adjustable lumbar support		Adjustable backrest	Adjustable armrests	Adjustable headrest	Manually adjustable tilt tension	Automatic tilt tension
Office chairs										
FLINTAN 	●		●							●
SMÖRKULL 	●		●				●			●
MARKUS 	●		●						●	
JÄRVFJÄLLET 	●	●	●	●			●			●
HATTEFJÄLL 	●	●	●	●		●	●			●
ALEFJÄLL 	●	●	●	●		●				●
GRÖNFJÄLL 	●	●	●	●		●	●	●		●

GRÖNFJÄLL

Full working day

office chair with armrests/headrest

This office chair features fully adjustable armrests and a curved headrest that minimises visual distractions. 10-year guarantee.



Tested for 110 kg. W71 cm, D71 cm.
Max seat height 57 cm, min seat height 46 cm.

Letafors grey/black 295.139.19

Letafors grey-green/white 795.139.26



3D adjustable armrests give you complete support.



The leather neck cushion has foldable side bolsters similar to those on airplane seats. Ideal for relaxing your head or taking a power nap.



LETAFORS fabric cover with cooling effect maintains a comfortable seat temperature during long working hours. The fabric is stain-resistant and easy to clean.



Seat and armrest covers are removable and washable.



Height-adjustable seat



Adjustable seat depth



Adjustable lumbar support



Adjustable headrest height



3D adjustable armrests



Automatic tilt tension



Synchronised tilt tension



Tilt lock



Removable washable cover, seat and armrest

GRÖNFJÄLL

Full working day

office chair with armrests

This office chair is brimming with ergonomic features to keep you comfy and focused, such as fully adjustable armrests and a curved headrest that minimises visual distractions. 10-year guarantee.



Tested for 110 kg. W71 cm, D71 cm.
Max seat height 57 cm, min seat height 46 cm.

Letafors grey/black 005.034.40

Letafors grey-green/white 805.329.24



3D adjustable armrests give you complete support.



Seat and armrest covers are removable and washable.



LETAFORS fabric cover with cooling effect maintains a comfortable seat temperature during long working hours. The fabric is stain-resistant and easy to clean.



Height-adjustable seat



Adjustable seat depth



Adjustable lumbar support



Adjustable headrest height



3D adjustable armrests



Automatic tilt tension



Synchronised tilt tension



Tilt lock



Removable washable cover, seat and armrest

ALEFJÄLL office chair with armrests

Full working day

This office chair has as a well-shaped backrest with adjustable backrest and soft full grain leather that breathes. 10 year guarantee.



Tested for 110 kg. W64 cm, D64 cm.
Max seat height 56 cm, min seat height 45 cm.

Grann golden-brown	404.199.82
Grann beige	503.086.86



Synchronised tilt mechanism allows the chair to move with you. This improves circulation and keeps energy levels up

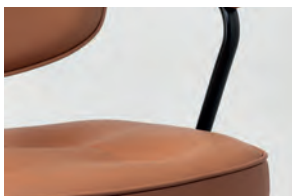

GRANN cover is made of grain leather which is a very high-quality leather. As it ages it becomes softer and develops a darker tone and fine patina.



Backrest can be adjusted to provide support in all the right places and helping your body to maintain a naturally good posture.

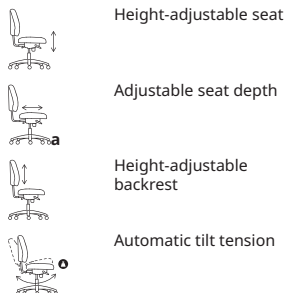

Height-adjustable seat

Adjustable seat depth

Height-adjustable backrest

Automatic tilt tension

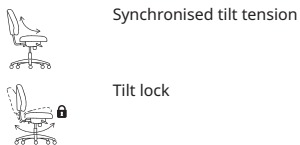

Synchronised tilt tension

Tilt lock

HATTEFJÄLL office chair with armrests

Full working day

This chair comes with adjustable lumbar support and a backrest that can be adjusted to 5 different positions. 10 year guarantee.



Tested for 110 kg. W68 cm, D68 cm, max height 114 cm.
Max seat height 56 cm, min seat height 46 cm.

Gunnared light green/white	705.329.53
Gunnared beige/white	605.389.55
Gunnared medium grey/white	605.389.60
Smidig black/black	505.389.65
Gunnared dark grey/black	305.389.71
Gunnared green/black	505.389.70



Height and width adjustable armrests enable a relaxed position for arms and shoulders and reduce the risk of tension.



Backrest can be adjusted to 5 different heights to provide support in all the right places and helping your body to maintain a naturally good posture.

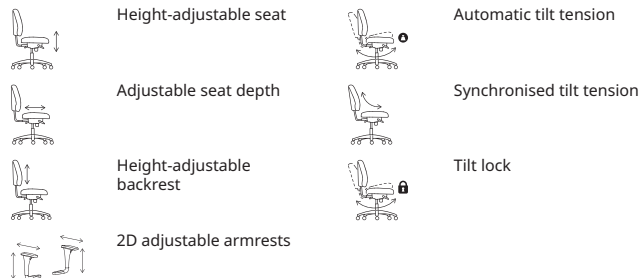

Height-adjustable seat

Adjustable seat depth

Height-adjustable backrest

2D adjustable armrests

Automatic tilt tension

Synchronised tilt tension

Tilt lock

JÄRVFJÄLLET

office chair with armrests

Full working day

This office chair keeps you comfy with a high backrest that provides good support, made with airy mesh so you stay cool. 10 year guarantee.



Tested for 110 kg. W68 cm, D68 cm, max. height 140 cm.
Max. seat height 56 cm, min. seat height 45 cm.

Glose black	805.106.39
Grann white	405.218.52

MARKUS

office chair with armrests

Occasional

This office chair comes with a manually adjustable tilt tension, and head-/armrests to help relax the muscles in your neck and back. 10 year guarantee.



Tested for 110 kg. W62 cm, D60 cm.
Max. seat height 57 cm, min. seat height 46 cm.

Vissle dark grey	702.611.50
Vissle light grey	105.218.58



The high backrest and the curved shape of the chair, provide good lower back support and prevent your back from getting tired.



Adjustable lumbar support helps maintain the correct posture while sitting which reduces strain on muscles on your lower back.



Adjustable tilt tension that allows you to adjust the resistance to suit your movements and weight. To adjust the tilt tension, turn the knob under the seat to increase or decrease the resistance.



Adjustable seat depth enables proper back support and even weight distribution across the seat cushion.



Height and width adjustable armrests enable a relaxed position for arms and shoulders and reduce the risk of tension.



Height-adjustable seat



Adjustable seat depth



Adjustable lumbar support



Adjustable headrest height



2D adjustable armrests



Automatic tilt tension



Synchronised tilt tension



Tilt lock



Height-adjustable seat



Armrests



Manual tilt tension



Synchronised tilt tension



Tilt lock

SMÖRKULL office chair with armrests

Occasional

This office chair blends easily into your living room at home or your office workspace. The cover is removable and washable. Comes with a 10-year guarantee.



Tested for 110 kg. W65 cm, D66 cm.
Max. seat height 56 cm, min. seat height 44 cm.

Gräsnäs dark grey	805.034.36
Gräsnäs red	605.034.37

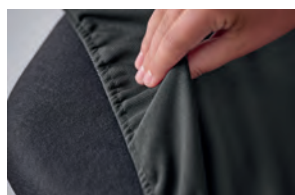

It's easy to keep the office chair clean, since the covers for backrest and seat are removable and machine washable.



The armrests follow your movements and can be adjusted in height, which reduces strain on your arms and shoulders.

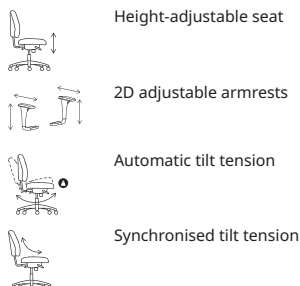

Height-adjustable seat

2D adjustable armrests

Automatic tilt tension

Synchronised tilt tension

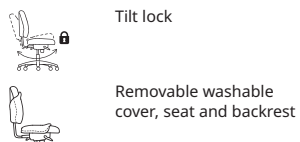

Tilt lock

Removable washable cover, seat and backrest

FLINTAN office chair

Occasional

This office chair with a high backrest provides good support. The airy mesh helps you to stay cool. Removable and washable seat cover. 10 year guarantee.



Tested for 110 kg. W71 cm, D71 cm.
Max. seat height 58 cm, min. seat height 45 cm.

Beige	094.244.67
Black	894.244.68

With armrests

Beige	704.922.02
Black	104.890.28



The cover is easy to keep clean as it is removable and machine washable.



The castors are rubber coated to run smoothly on any type of floor.

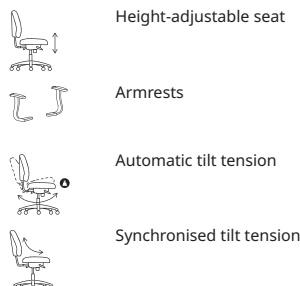

Height-adjustable seat

Armrests

Automatic tilt tension

Synchronised tilt tension

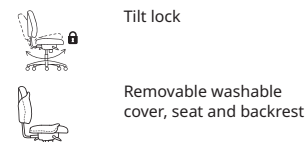

Tilt lock

Removable washable cover, seat and backrest

Room dividers and acoustic screens

Sharing a workspace with other people often means that there's going to be a lot of activity going on. Depending on the size and space of your office, it can be difficult to find a quiet spot where you can focus or where colleagues can meet and collaborate without disturbing others. The IKEA range offers solutions for creating separate spaces within a room while also helping to reduce noise.

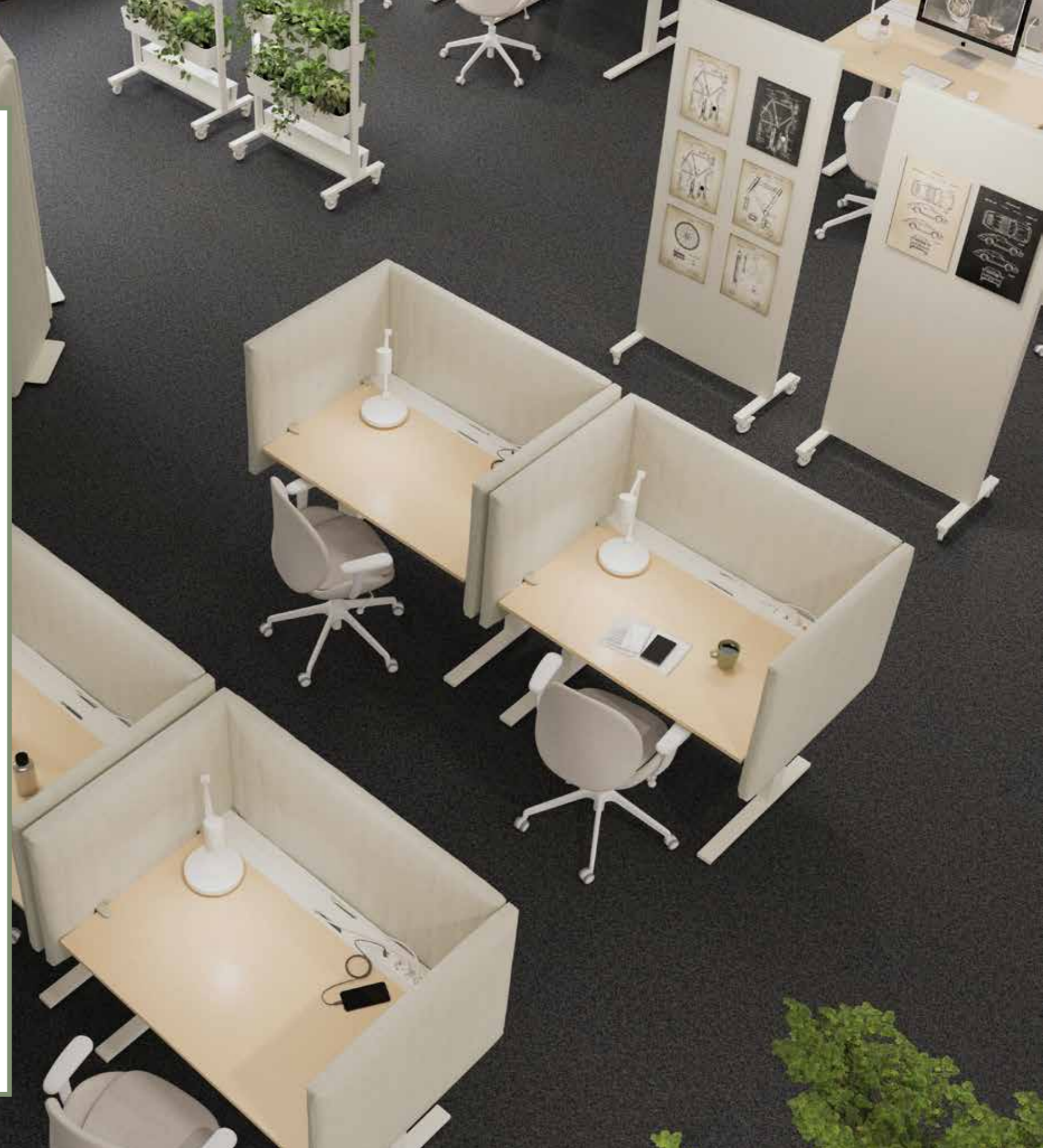

How would you like your space divided?

Dividing space in your office can be achieved in a variety of ways for different purposes. Whether you need to create privacy for individuals within a large open floor plan, form areas for collaboration or provide a lounge where colleagues can relax with a cup of coffee, screens and dividers are the most flexible and cost-efficient way to adapt the space to make it comfortable, functional and appealing.



MITTZON frames with castors

A flexible system to divide work areas or create a room within a room. Dress the frame with your choice of acoustic screen, whiteboard/noticeboard, shelves, containers for plants, cable box or clothes rails.

10

As confirmation of the high quality, our MITTZON frames with castors and acoustic screens have been developed and tested for office use and are backed by a 10-year guarantee.



MITTZON floor-standing acoustic screens

The floor-standing screens help to divide space and reduce noise levels. They can be adapted to the specific size and needs of your space.



MITTZON acoustic screens for desks

The desk-mounted screens are ideal for creating privacy around the desk and can effectively reduce the buzz from the surrounding environment.



Key features

MITTZON frames with castors



Divide your workspace with greenery. The lush and vibrant tones of nature beauty creates a calm space to wind down or let the green leaves inspire your creativity.



Dress the frame with shelves to display items your company is proud of or to store things like binders, books and office supplies.



Dress the frame with a whiteboard/noticeboard and handy storage for markers, pins and other tools needed for meetings or workshops.



Dress the frame with clothes rails and shelves to create a practical area to store coats, shoes, bags and helmets.



Dress several frames with acoustic screens to create a corner for working together. The screens absorb sound and are perfect for pinning up notes.



When using LED lighting strip in the frame, the cables are led through the frame interior into the cable box and then to a socket.

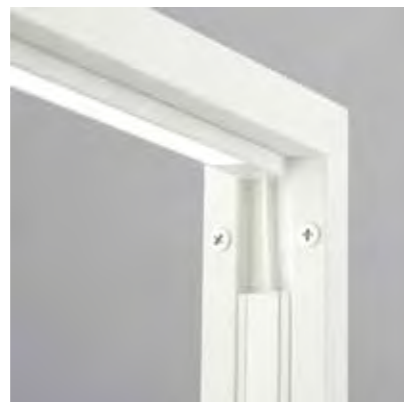

MITTZON acoustic screens

The lightweight acoustic screens mounted on frames with castors are ideal to divide space for a meeting or workshop or to create a room within a room. They are easy to move around and stay in place when you lock the castors.

1. Work with sound absorption.



Non-porous materials like glass, MDF or concrete cause sound to reflect, creating echoes while porous materials like curtains, seat covers and rugs absorb sound. Acoustic products like desk screens and floor-standing screens also absorb sound and help to balance the presence of non-porous materials.

2. Block the sound.



Divide the space into separate acoustic zones using various types of barriers to prevent sound from traveling freely in an open landscape or between two workstations. Desk and floor-standing acoustic screens as well as acoustic screens on castors are ideal for this purpose.

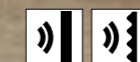

Acoustic desk screens fit MITTZON desks perfectly giving you a calm and secluded workspace where you can focus.

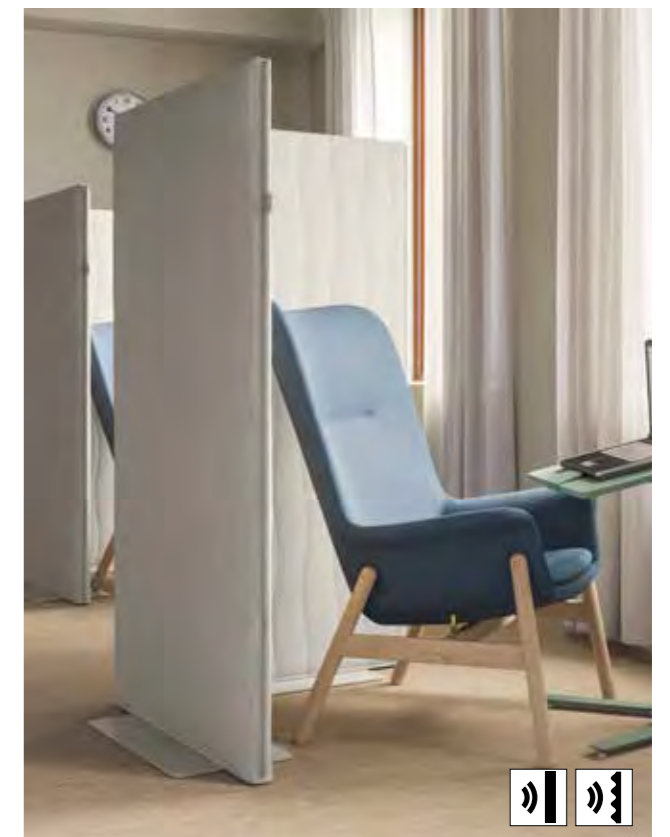

Use acoustic floor-standing screens between desks or use several screens to form a focus area. Experience lower sound levels and greater possibility to concentrate.

What you need to know when choosing acoustic products

Our acoustic products have been developed and tested together with acoustic specialists to ensure they meet sound absorbing and sound-blocking requirements. This is what you need to know when choosing acoustic products for your office area.

Work with sound absorption and sound-blocking.



Acoustic screens for desks and floor-standing screens are ideal to block the sound from travelling in the room and to absorb sound waves. The acoustic screens are easy to move around (without changing the architecture of the room) and to create quieter spaces that are more conducive to working and collaborating.

Wood fibre filling with excellent acoustic performance

Our acoustic screens are constructed with a low-density fibreboard core surrounded by a thick, wood fibre filling that has been tested and proven to effectively absorb sound. The filling contains 92% renewable and recyclable wood fibre content and has excellent acoustic performance.

Easy maintenance



The acoustic screens are dressed with a thick, durable fabric that is removable and machine washable for your convenience.

How to mount the screens



It is easy to attach the side screen for desks using the included clamps. The back-mounted screens can be attached with the help of L-shape bracket. To connect 2 or more floor-standing acoustic screens use the included rounded wooden rods on the sides and the plastic clips. See more in the assembly instruction.



The back-mounted screen is easy to attach to MITTZON desk using the included L-shaped bracket.

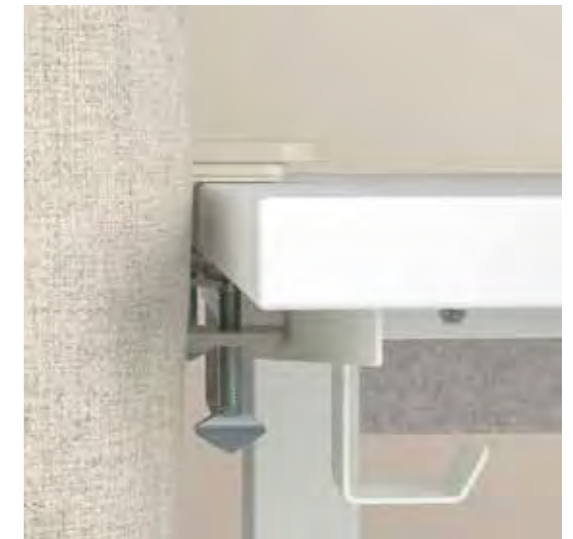

The side-mounted acoustic screen is easy to attach using the included clamps.



Floor-standing acoustic screens can be connected with an included plastic clip.

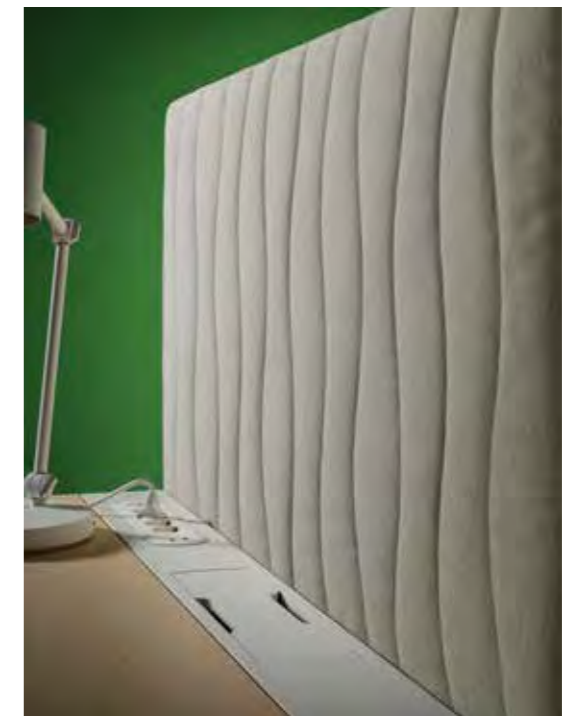

The flowy pattern on the quilted screens reminds of sand ripples formed by waves on the beach.

MITTZON

Frames with castors



**Frame with castors/clothes rail/
display shelf.**
W85D×50×H205 cm
White 795.364.14



**Frame with castors/clothes rail/
display shelf.**
W85D×50×H205 cm
White 295.139.57



Frame with castors/coat rack.
W85D×50×H205 cm
White 295.364.21



**Frame with castors, whiteboard, dis-
play shelf.**
W85×D50×H205 cm
White 595.146.82



**Frame with castors, acoustic screen,
whiteboard.**
W85D×50×H205 cm
Gunnared
beige/white 095.361.77



Frame with castors, acoustic screen.
W85D×50×H205 cm
Gunnared
beige/white 395.146.83



**Frame with castors/container/
cable box.**
W85D×50×H205 cm
White 395.146.78



Frame with castors/container.
W85D×50×H205 cm.
White 095.729.62



Frame with castors, display shelf.
W85D×50×H205 cm
White 495.361.75



**Frame with castors/display shelf/
cable box.**
W85D×50×H205 cm.
White 395.623.63



**Frames with castors, container, dis-
play shelf, cable box.**
W85D×50×H205 cm
White 595.146.77



Acoustic screens



Acoustic screen for desk, back-mounted.
Gunnared beige.

W125×H72×8 cm	405.282.12
W145×H72×8 cm	405.281.94
W165×H72×8 cm	705.282.15



Acoustic screen for desk, side-mounted.
Gunnared beige.

W70×H72×8 cm	105.282.23
W90×H72×8 cm	105.282.18



Acoustic screen floor-standing.
Gunnared beige.

W70×H157×30 cm	105.282.04
W90×H157×30 cm	605.282.06



Acoustic screen for frames with castors.
Gunnared beige.

W85×H205×D50 cm	205.286.37
-----------------	------------



Conference tables

The way we think about and plan our workspaces is changing with increased focus on creating spaces that make us feel comfortable, relaxed and empowered to focus on the task at hand. Many offices are becoming more activity based, meaning different settings are created for different purposes. When it comes to meeting spaces in particular, it is a good idea to create different solutions for both formal and informal meetings as well as workspaces especially suited for collaboration.

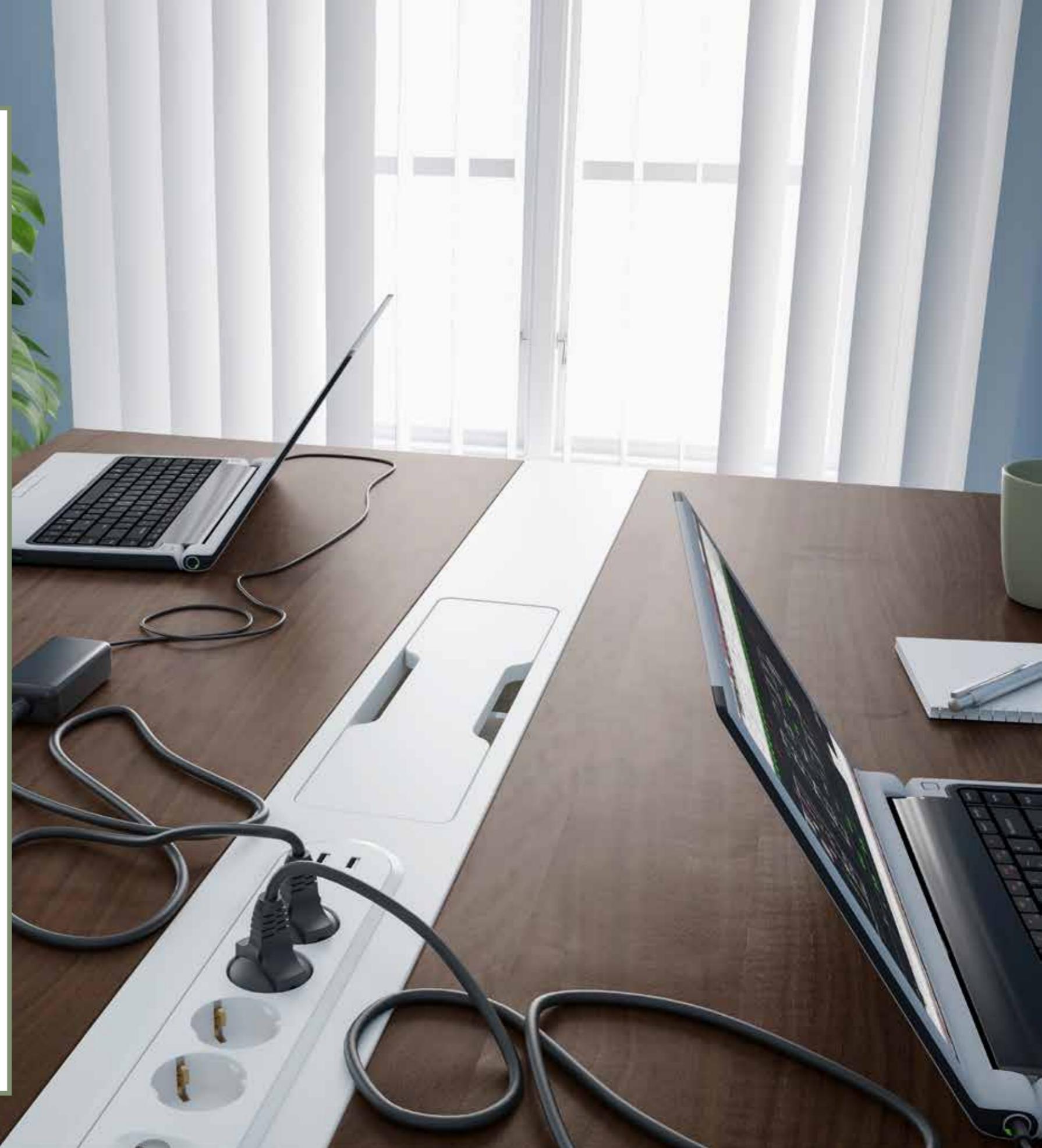

What types of meetings would you like to have?

Providing a diversity of meeting spaces with tables to accommodate the activity, sets the stage for comfort, well-being and higher productivity. Our range includes a wide variety of conference tables to suit your style, office layout and the type of meeting you would like to have.



Break out of the cubicle!
Areas for quick face-to-face meetings support the flow of creative ideas.

10

As confirmation of the high quality, our TROTTEEN, MITTZON and IDÅSEN tables have been developed and tested for office use and are backed by a 10-year guarantee.

MITTZON conference tables

Just like MITTZON desks, the conference tables are all about function, quality and comfort contributing to your well-being and ability to focus. The durable tabletops are available in 2 shapes (round or rectangular) and several sizes with the same range of finishes as for the desks so you can create a beautifully coordinated workspace. Choose between low-gloss white and 4 different wood veneers with tactile feel. Combine the tops with a white or black steel underframe with a height suitable for either sitting, standing or both.



TROTTEEN table (80×80×102 cm)

Our TROTTEEN series includes a slightly higher table that can be placed on its own or in the company of other TROTTEEN tables to create a meeting or collaboration area. And just like TROTTEEN desk, the neutral beige tone is gentle on your eyes as it creates a soft contrast between the screen and tabletop.



IDÅSEN tables

Inside or outside a meeting room, sitting or standing, long sessions or short creative break-outs. IDÅSEN tables support all different ways for you to work and collaborate.



Key features

MITTZON conference tables



The foldable table is easy to move and store. You can park several folded tables next to each other using minimal space.



Roll the table out, place it with others and let the meeting begin. When it's time for clean-up, simply fold it, roll it back and store it.



The round conference table is ideal for small, informal meetings. When everyone faces each other, they feel more engaged and involved.



The high conference table with footrest provides well-needed support for your legs during long meetings or phone calls.



MITZZON conference tables pair perfectly with LÅNGFJÄLL chairs.



The low conference tables are ideal for meeting rooms or working independently, side-by-side in open co-working areas. The tables can be put together to create small, medium or large solutions that fit your needs and space.



This wide conference table has a plug-in module so you can stay charged while working. Accessible from above.

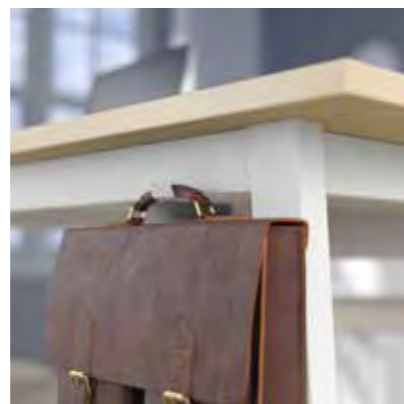

2 hooks on each side of the conference table allows you to hang bags or headphones within easy reach.



The conference tables pair perfectly with LÅKTARE conference chairs.

TROTTEEN tables



Use one table or position several together to create a work area for a creative meeting. When the meeting is over, you can easily move the tables apart again. The high TROTTEEN tables have castors which make them easy to move around. The castors are lockable so the tables stand steady wherever you choose to put them.



By combining 2 or more TROTTEEN desks you can create an efficient area for meetings, collaborating on projects or brainstorming.



The neutral beige colour is gentle on your eyes as it creates a soft contrast between the screen and tabletop.



A hook on each side of the table allows you to hang your bag or headphones within easy reach.



Use one table independently or position several together to create a work area for a creative meeting. When the meeting is over, you can easily move the tables apart again.

IDÅSEN tables



TROLLBERGET sit/stand support pairs perfectly with the high IDÅSEN table.



IDÅSEN tables have a prominent wood pattern that adds a warm and natural expression to the room.



How to build MITTZON conference tables

01

Start with the shape and size.

You can choose Ø120 cm or widths 120 and 140 cm. The rectangular shape comes in depths of 68 or 108 cm.

02

Choose your favourite expression.

Do you prefer a tabletop in low-gloss white or a more natural look with walnut, oak, birch or black-stained ash veneer?

03

Combine with underframe (and plug-in module)

Choose between black or white and the heights 75 or 105 cm whether you want to sit or stand or have the option to do both.

Round table. Ø120 cm. Height 75 cm. It has a small compartment perfectly sized for KOPPLA cable socket (sold separately) or smaller items like pens and post-its.



Measurement details:

The 68 cm deep conference table uses a single tabletop.

The 108 cm deep conference tables use 2×48 cm deep tabletops and 1 plugin module 12 cm. The plug-in modules are available in black or white to coordinate with the underframes.

Conference table. 140×68 cm. Height 75 cm.



Conference table. 140×108. Height 75 cm. This combination contains 2 table tops with depth 48 cm and 1 plug-in module for cable management.



High conference table. 140×68 cm. Height 105 cm.



High conference table. 120×108 cm or 140×108 cm. Height: 105 cm.
This combination contains 2 tabletops with depth 48 cm and 1 plug-in module for cable management.



Be flexible with MITTZON foldable tables

The foldable tables are ideal for collaboration spaces and meeting rooms that need to be adapted easily to different needs.

Just connect/lock them in place and separate again when the meeting is over.



Several tables can be connected/locked in place and separated when the meeting is over for easy maintenance.

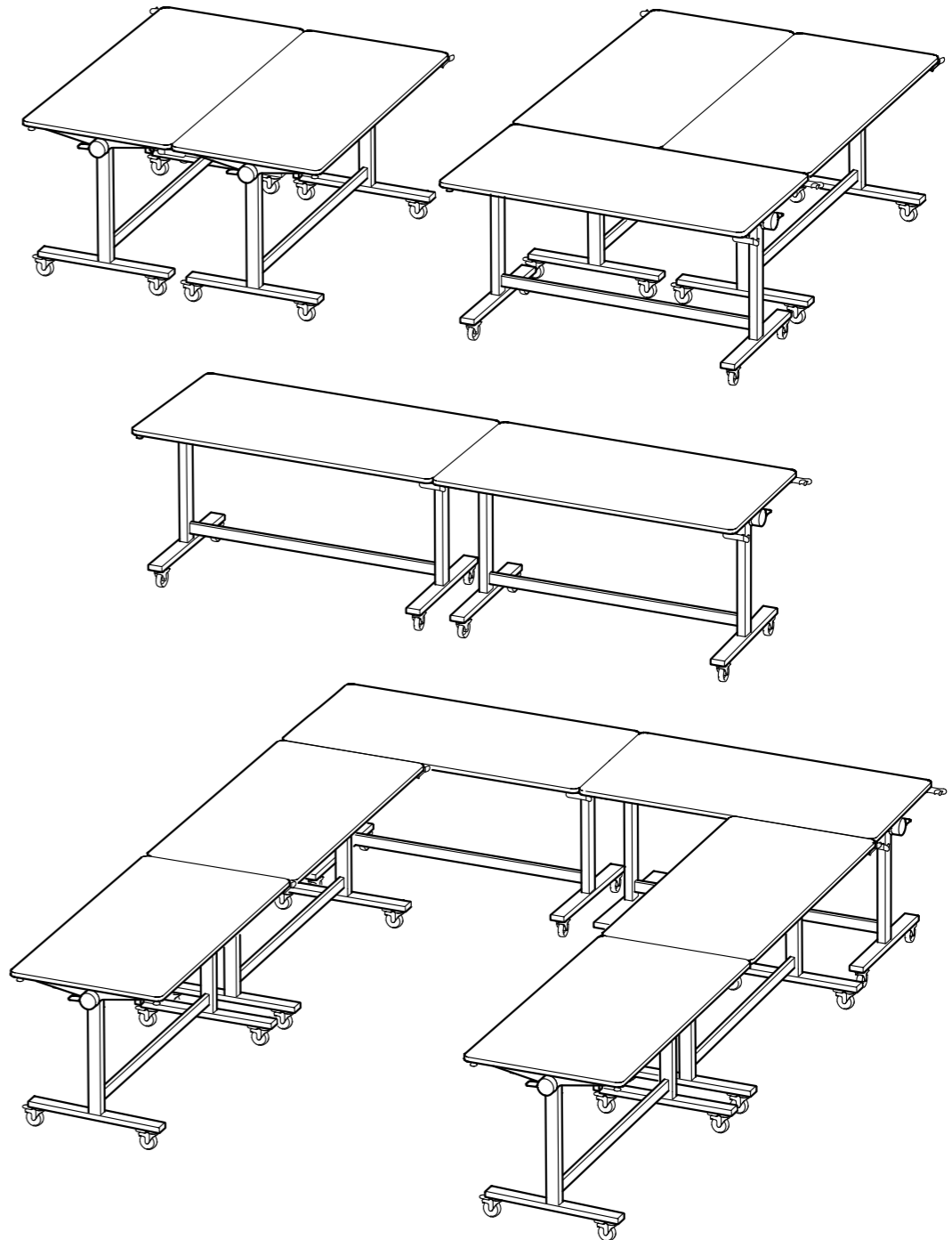

MITTZON

Foldable table with castors



W140×H70 cm

Green	805.279.51
Black	405.279.48
White	205.279.54



Several tables can be locked together using the included connectors. For easy maintenance, they can be unlocked and separated again when the meeting is over.

Conference table (round)



Ø120×H75 cm

Birch veneer/white	995.139.30
Black stained ash veneer/white	595.304.46
Oak veneer/white	595.305.02
Walnut veneer/white	095.305.09
White	695.304.41
Birch veneer/black	395.304.28
Black stained ash veneer/black	195.304.53
Oak veneer/black	095.304.58
Walnut veneer/black	195.305.04
White/black	895.304.35



This table has a small compartment perfectly sized for KOPPLA cable socket (sold separately) or smaller items like pens and post-its.

Conference table

From small to x-large. This versatile conference table can be set up on its own or together with others to create the perfect meeting and/or work area where great ideas evolve.



140×68×75 cm

Birch veneer/white	295.329.94
Black stained ash veneer/white	795.330.00
Oak veneer/white	795.329.20
Walnut veneer/white	695.330.05
White	295.329.89
Birch veneer/black	695.329.92
Black stained ash veneer/black	395.329.98
Oak veneer/black	395.139.52
Walnut veneer/black	195.330.03
White/black	095.329.85

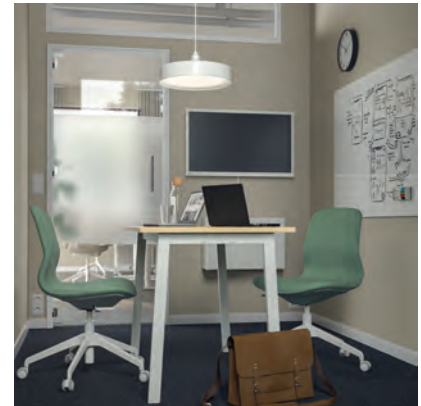

Ideal for open co-working areas, meeting rooms or to create a small workspace.

From small to x-large. This conference table can be set up on its own or together with others to create an ideal meeting or work area where great ideas evolve. Clever cable management for easy plug in.



140×108×105 cm

Birch veneer/white	095.333.86
Black stained ash veneer/white	595.333.98
Oak veneer/white	795.334.20
Walnut veneer/white	995.334.24
White	195.333.81
Birch veneer/black	595.333.84
Black stained ash veneer/black	195.333.95
Oak veneer/black	995.334.07
Walnut veneer/black	395.334.22
White/black	795.333.77



The included cable management module allows you to charge devices while working. Compatible with all outlets globally, accessible from above.

TROTTE

Table (desk with A-legs)

Thanks to the flexibility of the desk, it's a great workspace for one person, and by combining several desks you can create an efficient area for meetings, collaboration or brainstorming.



120×70×75 cm

White	294.249.42
Beige/white	494.343.89
Beige/antracite	094.295.68
White/antracite	494.295.71

140×80×75 cm

White	594.295.56
Beige/white	994.342.59
Beige/antracite	894.295.50
White/antracite	294.295.53



You can hang essentials like your bag or headphones within easy reach on the two hooks on the sides of the table.

160×80×75 cm

White	994.295.59
Beige/white	694.342.70
Beige/antracite	694.295.65
White/antracite	394.295.62

High table

These tables are perfect for spontaneous meetings, creative brainstorming or temporary workspaces. They're easy to move, yet still sturdy. Use them on their own – or position several together!



80×80×102 cm

White	094.296.05
Beige/white	894.369.75
Beige/antracite	094.296.10
White/antracite	494.296.08



The castors make the tables easy to move around. They are lockable, so the tables stand steady wherever you choose to put them.

IDÅSEN

Table

Inside or outside a meeting room, sitting or standing, long sessions or short creative break-outs. IDÅSEN tables support many different ways for you to work and collaborate.



140×70×75 cm

Black/beige	393.996.02
Black/dark grey	693.958.91
Brown/beige	993.958.99
Brown/dark grey	393.995.98

High table



140×70×105 cm

Black/beige	393.995.41
Black/dark grey	893.958.85
Brown/beige	293.958.88
Brown/dark grey	993.995.38



You can hang your bag or headphone on the hook underneath.



TROLLBERGET sit/stand support provides ergonomic comfort when sitting at IDÅSEN high table.



Combine any number of tables as you like and create a solution that suits you and your team – for meetings, creative workshops, collaborations and individual tasks.



IDÅSEN tables have a prominent wood pattern that adds a warm and natural expression to the room.

IDÅSEN low table pairs perfectly with MULLFJÄLLET conference chair.

Conference chairs

With beautifully designed conference chairs, blending into the entire office range you can create an overall inviting and coordinated expression that also reflects the identity of your company. It is important that the conference chair gives the support and comfort you need depending on the type of meetings you have and the available space. We have many options to choose from.





Key features

LÅNGFJÄLL conference chairs



The lumbar support helps maintain a correct posture while sitting and reduces strain on lower back muscles.



A tilt mechanism can be adjusted to suit your weight and movements allowing you to lean back with perfect balance.

LÄKTARE conference chairs



Removable and washable cover for easy maintenance.



Save space when the chairs are not in use. Stack up to 5 chairs with fabric cover, or 7 chairs without the cover.

MULLFJÄLLET conference chairs



The design is enhanced with curved lines, sewn details and an easy-use, hidden mechanism under the seat.



The durable, perfect-fit fabric cover is easy to keep clean since it is removable and machine washable.

TOSSBERG conference chairs



The high, curved backrest supports your lower back and prevents it from getting tired. You sit comfortably, longer and with a relaxed posture.



TOSSBERG conference chair comes with rounded shapes and comfy padding. The durable fabric blends well in any room.

FJÄLLBERGET conference chairs



You sit comfortably since the chair is adjustable in height.



FJÄLLBERGET conference chair is versatile with an elegant shape and compact design.

Key features

LIDKULLEN active sit/stand support



Removable and washable cover for easy maintenance.



A smart mechanism keeps your body in constant motion, strengthens muscles and the spine – and gives you a naturally healthy posture.

TROLLBERGET active sit/stand support



The leather ages beautifully and acquires a nice patina over time.



Changing positions between sitting and standing keeps your body in movement so you both feel and work better.

How to choose conference chair

Beyond the aesthetics, there are features that can significantly impact your comfort. That is why it is important to choose a chair that accommodates the types of meetings you have.

01

How long are your meetings?

A high table with sit/stand support is ideal for ad hoc meetings or to work whilst on the go.

For break-outs or more spontaneous workshops, a good solution is to use sturdy yet lightweight and stackable chairs that are easy to store away when not needed.

To keep your energy up during longer meetings or work sessions, we recommend chairs that are specifically comfy and kind to your body. Upholstered seat and backrest are essential, and tilt and heightadjusting mechanisms will enable individual comfort and variation.

02

Look for these features:

Lumbar support

Good lumbar support is crucial for preventing back pain. The backrest should support the natural curve of your lower back.

Seat padding

The seat and back should have enough padding to be comfortable for long periods of sitting. Removable and washable covers enable you to keep your meeting room looking fresh.

Swivel and mobility

Conference chairs that rotate, swivel and/or have castors enable movement and help to keep comfort and energy levels up.

Stability

A conference chair with castors should have a five-point base to reduce the risk of tipping over when leaning or moving in the chair.

Armrests

Armrests provide support for the upper part of your forearms and reduce strain on back and shoulders.

MULLFJÄLLET conference chair

"When designing MULLFJÄLLET conference chair I wanted to create a chair that exudes comfort in its shape, materials and crafted details. The functions and expression make the chair suitable for both a workspace at home and at the office."

Designer Francis Cayouette



Whether you're attending longer meetings in the office or simply checking emails at home, MULLFJÄLLET conference chair will provide you with excellent support. The sleek design will complement any space, making it both functional and stylish.

Multiple uses to fit your ever-changing needs

Create a versatile and efficient space with MITTZON foldable tables and stackable LÄKTARE conference chairs. Without sacrificing style and comfort you can transform your space with ease and endless possibilities!



LÄKTARE conference chair is light yet sturdy and also stackable to save space when not in use.



Create an on/off solution for brainstorming or occasional gatherings with MITTZON foldable tables and LÄKTARE conference chairs. When the activity is over, just fold the tables, stack the chairs and store away.

LÅNGFJÄLL

Conference chair



This easy-to-place conference chair with gently curved lines accentuated by sewn details is kind to your body and pleasant to look at. The tilt and height-adjusting mechanism enables individual comfort.

Low back

Without armrests. Seat W53×D41 cm, H43-53 cm.

Gunnared beige/white	192.523.66
Gunnared green-grey/white	995.060.67
Gunnared beige/black	891.775.66
Gunnared green-grey/black	295.060.56

With armrests. Seat W53×D41 cm, H43-53 cm

Gunnared beige/white	492.527.65
Gunnared green-grey/white	995.068.16
Gunnared beige/black	191.778.57
Gunnared green-grey/black	395.077.29



Armrests provide support for the upper part of your forearms and reduce strain on the back and shoulders during long meetings.

High back

Without armrests. Seat W53×D41 cm, H43-53 cm

Gunnared beige/white	092.524.80
Gunnared dark grey/white	392.525.15
Gunnared beige/black	491.776.29
Gunnared dark grey/black	791.776.42

With armrests. Seat W53×D41 cm, H43-53 cm

Gunnared beige/white	092.527.91
Gunnared dark grey/white	292.528.65
Gunnared beige/black	291.780.69
Gunnared dark grey/black	291.780.74



The high back follows the natural curve of the spine. It offers good lumbar support, helping to maintain a proper posture while seated, and reducing strain on the lower back.

LÄKTARE

Conference chair



Minimalist Scandi-design in natural, light birch veneer which can be combined with your choice of cover. The sturdy yet lightweight chair is stackable to save space but can also be hung on the table for easy cleaning.

Seat W46×D42cm, H45 cm.

Birch veneer/white	095.031.91
Medium grey/white	495.032.50
Light beige/white	895.032.72
Light green/white	495.032.45
Birch veneer/black	995.032.57
Medium grey/black	595.032.64
Light beige/black	295.032.08
Light green/black	395.032.60



Pairs perfectly with MITTZON conference tables in the office area and also in cafés and restaurants.

MULLFJÄLLET

Conference chair



Long meetings are no problem when you can spend them in this chair with a generous, padded seat and curved backrest. And don't worry about coffee stains – just toss the cover into the washing machine.

Without armrests. Seat W54×D45cm, H47–59cm.

Naggen beige	004.724.91
Naggen dark grey	804.724.92

With armrests. Seat W54×D45cm, H47–59cm.

Naggen beige	193.997.97
Naggen dark grey	193.998.15



Upholstered armrests that provide comfort and allow you to vary your sitting position at the table.

TOSSBERG

Conference chair



Swivel chair with soft shapes and comfy padding. Upholstered in a durable fabric that blends well in all types of rooms – and with castors that make it easy to move.

Seat W44×D40cm, H45.57cm

Grann black/black	895.121.63
Grann black/white	195.096.92
Grann light brown/black	995.130.96
Grann light brown/white	095.130.91
Gunnared beige/black	495.131.12
Gunnared beige/white	595.131.02
Gunnared dark grey/black	195.131.23
Gunnared dark grey/white	395.131.22



The high-resilience foam retains its shape and allows air to circulate, giving you a comfortable surface to sit on.

FJÄLLBERGET

Conference chair



Seat W42xD40 cm, H43-56 cm.

Black stained ash veneer/Gunnared dark grey 004.852.43

White stained oak veneer/Gunnared beige 803.964.22



The moulded high-resilience foam provides great comfort that will last for years.

LIDKULLEN

Active sit/stand support

This sit/stand support helps you to sit actively. The mechanism keeps your body in constant motion, strengthens muscles and the spine, and gives you a naturally healthy posture.



Seat W38 cm, H59-81cm

Gunnared dark grey

304.457.74

Office storage

Whether your workspace is small or large, you will need storage and clever desk organisers to arrange everything from important documents to pens and staplers. This keeps your workspace looking its best and saves time on endless searching. IKEA office storage comes in a variety of expressions, shapes and sizes all designed with function and quality in mind.



What do you need to store?

It may seem an obvious question, but worth a few minutes of consideration. Do you need open storage for quick and easy access? Are your items organised and ready for display? Or would it be better to have closed storage where things are kept out of sight?



10

As confirmation of the high quality, our TROTTEEN, GALANT and IDÅSEN products have been developed and tested for office use and are backed by a 10-year guarantee.



TROTTEEN office storage helps keep things organised and easy to find. Freestanding cabinets, drawer units and storage unit on castors enable you to divide spaces while providing easy-access storage. For smaller spaces, the wall-mounted storage is ideal.



GALANT series comes with a beautiful grain pattern, lockable storage and cable management. For open storage, the series offers generous solutions that you can place in the middle of a room since the back is finished. Adjustable shelves allow you to customise the solution to your needs.



IDÅSEN storage has a soft and calm expression that works well both for professional and home office spaces. The series includes open and closed storage, with drawers or doors in metal or glass. IDÅSEN shelving unit offers generous space for your office supplies and works well as a room divider between workspaces.



HÅLLAN cabinets in powder-coated steel can be combined in many ways to suit one or several co-workers. Put magnets on the outside and use it as a memo board. On the inside you can store everything from paper and binders to chargers and keys – just add a padlock and you have everything securely stored.

Key features

TROTTEEN



The 55 cm deep cabinets are accessible from both sides and can be used as room dividers.



The drawer unit is lockable so you can securely store your belongings.



Dimensioned for a perfect fit next to TROTTEEN desks to create more workspace and handy storage.

HÄLLAN



You can customise the storage since the shelves are height adjustable and removable.



Use magnets to attach photos or messages to the storage.



Several units can be combined to create a larger storage solution.

GALANT



This generous drawer unit will easily hide work-related items while keeping them close at hand.



The sliding doors close silently and gently thanks to the integrated damper.



The combination lock lets you safely store your things using a code that you pick.

IDÅSEN



Space behind the shelves allow you to collect cables and lead them through the outlet in the back.



In IDÅSEN high cabinet each colleague can have their own space for storing. With magnets, it can double as a memo board.



This neat drawer unit on castors can be easily rolled in under the desk or moved to where you need it.

How to choose the right storage for your workspace

When choosing your office storage, there are important factors to consider. Size and function need to be adapted to your available space and the types of items you need to store. When the style goes hand-in-hand with the rest of the décor, everything falls into place it becomes an expression of your company.

01

What's your style?

Most people appreciate the sense of calm that comes from an appealing and coordinated workspace. Our TROTTEEN, IDÅSEN and GALANT series offer a range of coordinated storage products in a variety of expressions.

03

Safe and organised

Filing cabinets help keep important documents organised and cuts down on clutter. Look for features like drawer stops which prevent drawers from being pulled out too far, and integrated dampeners which make drawers close silently and softly. When certain documents are for your eyes only, choose storage with built-in locks.

02

Open or closed storage?

Open storage gives easy access to often-used items and allows you to put things on display. Open storage usually comes with adjustable shelves and can sometimes be customised with doors or drawers to fit your unique storage needs. With closed storage, you can hide cluttering items and create a more uniform appearance.

04

Work from home like a pro

When your home doubles as a place of work, look for flexible and versatile storage solutions that fit your space, and can be moved around or rearranged.

Desk organisers



VATTENKAR portable organiser is ideal for switching workspaces at home or at the office. Personalise the pegboard with SKÅDIS accessories of your choice.



Organise those papers and magazines that tend to float around your office. DRÖNJÖNS metal mesh storage is lightweight and saves time since you can quickly see what's inside.



RISATORP basket with compartments is handy for things that you often move between different workplaces.



KVISSLE wall newspaper rack makes clever use of your walls and the clean expression blends in just about anywhere.



DRÖNJÖNS compact storage, keeps stationery and desk accessories organised and the metal mesh makes it easy to find everything.



RISATORP desk organiser has 2 compartments for storing desk supplies. The metal mesh makes it easy to find everything.



VATTENKAR is a drill-free and space-wise storage solution that can be placed against a wall or between two desks as a divider. Handy for plants or smaller desk items. Adjustable in 3 positions.

TROTTEEN

Storage



TROTTEEN cabinet with sliding doors.

80×55×75 cm

White	404.747.61
Anthracite	004.748.38



TROTTEEN cabinet with sliding doors.

80×55×110 cm

White	604.747.60
Anthracite	204.748.37



TROTTEEN cabinet with doors.

70×35×110 cm

White	304.747.71
Anthracite	604.748.35



TROTTEEN cabinet with doors.

70×35×173 cm

White	304.747.66
Anthracite	404.748.36



TROTTEEN cabinet with sliding doors.

80×55×180 cm

White	804.747.59
Anthracite	804.748.39



TROTTEEN cabinet with sliding doors/noticeboard.

80×55×180 cm

White	194.296.43
Anthracite	494.296.46



TROTTEEN drawer unit.

34×53×56 cm

White	204.747.62
Anthracite	404.748.41



TROTTEEN drawer unit with 3 drawers on castors.

40×47×56 cm

White	804.850.98
Anthracite	704.850.94



This cabinet provides space for storing things like papers, binders and chargers. When objects are hidden behind doors, you can enjoy a clutter-free space.

GALANT

Storage



GALANT file cabinet.

51×45×120 cm

White	803.651.85
Black stained ash veneer	303.651.83



GALANT cabinet with doors.

80×45×120 cm

White	103.651.41
Black stained ash veneer	503.651.39



GALANT cabinet with sliding doors.

160×45×120 cm

White	303.651.35
Black stained ash veneer	203.651.31



GALANT cabinet with sliding doors.

160×80 cm

White	104.728.67
-------	------------



GALANT drawer unit.

80×45×80 cm

White	903.651.61
Black stained ash veneer	303.651.59



GALANT drawer unit with drop-file storage.

80×45×80 cm

White	003.651.65
Black stained ash veneer	303.651.64



GALANT drawer unit on castors.

45×60×55 cm

White	103.651.55
Black stained ash veneer	603.651.53



GALANT cabinets have adjustable shelves so you can adapt the storage according to your needs.

BEKANT

Storage



BEKANT storage unit on castors.

41×101 cm.

Mesh/black	205.913.70
Mesh/white	605.913.73



IDÅSEN

Storage



IDÅSEN high cabinet with drawer and doors.

45×47×172 cm

Beige	503.207.25
Dark green	104.964.01



IDÅSEN cabinet with drawers and doors.

80×47×119 cm

Beige	303.207.26
Dark green	904.963.98



IDÅSEN cabinet with sliding glass doors.

120×45×140 cm.

Beige	803.609.51
-------	------------



IDÅSEN shelving unit.

120×45×140 cm.

Beige	104.737.82
-------	------------



IDÅSEN drawer unit on castors.

42×47×61 cm.

Beige	103.207.27
Golden.brown	503.979.13



IDÅSEN shelving unit is ideal as a room divider since it has the same finish on the front and back and is accessible from both sides.

HÄLLAN

Storage



HÄLLAN storage combination with doors.

45×47×67 cm.

White

892.913.12



HÄLLAN storage combination with doors.

45×47×92 cm.

White

192.913.15



HÄLLAN storage combination with doors.

45×47×117 cm.

White

792.493.28



HÄLLAN storage combination with doors.

45×47×142 cm.

White

592.494.09



HÄLLAN storage combination with doors.

45×47×167 cm.

White

892.494.03



HÄLLAN storage combination with doors.

45×47×167 cm.

White

492.493.96



HÄLLAN storage combination with doors.

90×47×167 cm.

White

192.494.06



HÄLLAN storage combination with doors.

90×47×167 cm.

White

892.493.99



HÄLLAN storage combination with doors.

90×47×167 cm.

White

992.495.20



HÄLLAN storage combination with doors.

135×47×192 cm.

White

392.766.82



Several HÄLLAN units can be combined to create a larger storage solution.

Lounge areas

Relax and let the creativity flow

How we work has changed in recent years and companies are increasingly seeing the benefits of having an area in the office that promotes spontaneous interactions in a relaxed atmosphere. These types of meetings are not only important for building relationships, they also enhance collaboration and problem solving.

The IKEA range offers a variety of furnishings that can be used to create a welcoming, comfortable and vibrant lounge area where you can work alone, discuss things with colleagues or clear your mind over a cup of coffee. And with the right technology, the lounge can easily transform into a large gathering space for presentations and events.



LILLEHEM sofa series

Flexible and inviting seating

The versatile LILLEHEM series of modular sofas can be configured into endless combinations to create a comfortable lounge area after your specific space and needs. The modules can be rearranged and added onto, for different activities. Choose from a range of covers and legs to create a vibrant and welcoming expression. All covers are removable and washable.

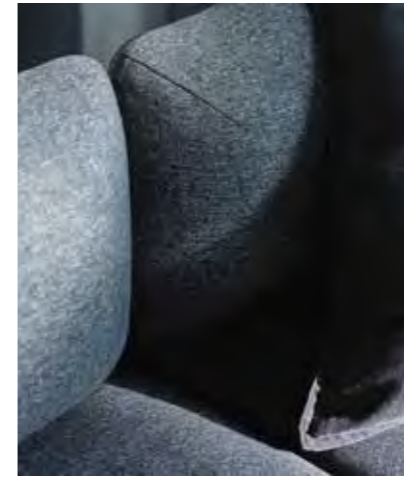
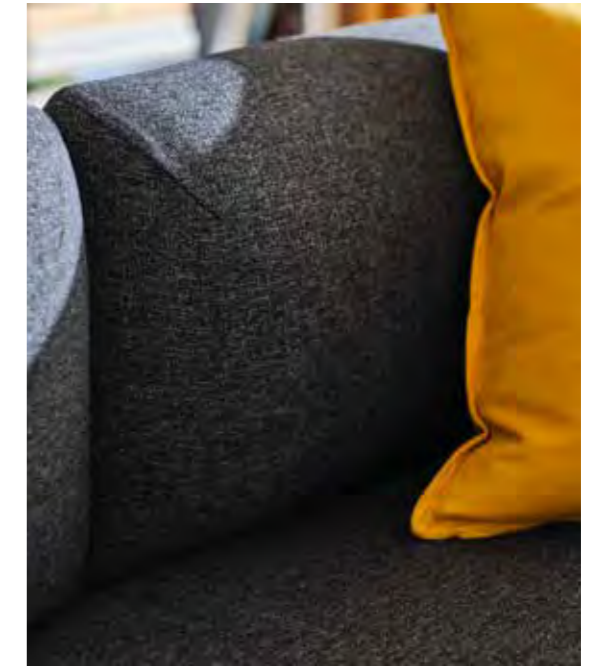

Key features

OSKARSHAMN armchair



Who doesn't dream of having their own nook to relax in? OSKARSHAMN wing chair embraces with its timeless design.

HERRÅKRA armchair

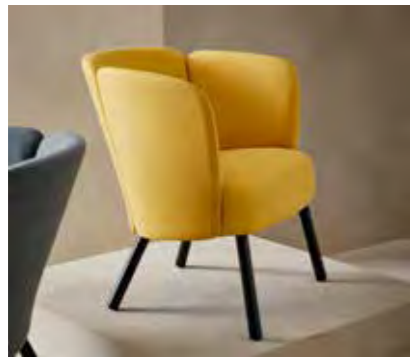

A bold look with charmingly rounded shapes, upholstered in an easy-care fabric.

BINGSTA armchair



The stylish design is enhanced by the armchair's slim legs and two tone-in-tone yellow colours.



The curved, embracing back panel gives you comfy me time in a private nook, even in open-plan environments.



HERRÅKRA armchair goes just as well in a lounge area as in a waiting room or reception.

Side tables and laptop tables



MITZON laptop table is ideal for creating a small workspace to check emails in a lobby. It is foldable and easy to move to where it is needed.



The laptop table is height adjustable and can also be used as a stand for presentations.



Versatile TUNSTA side table is designed to complete our modern-styled sofas. Use it as a coffee table or as a side table.

FRÖSET easy chair



Comfort is built in – the generous and slightly bent seat, the rounded shape of the backrest and the angle between them helps you to sit relaxed.

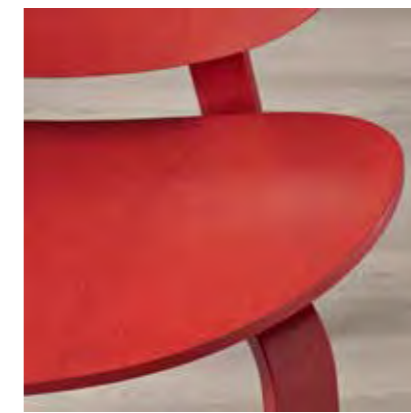

Clean Scandinavian design made entirely of layer-glued wood.



The table top's smooth finish and square shape is a functional solution for any office.

Key features

Dining tables



RÖNNINGE bar table. A stable construction in solid wood and hardwood veneer that makes each table unique, with varying grain patterns and natural colour shifts that are part of the charm of wood.



RÖNNINGE bar table. Durable and hardwearing; meets the requirements on furniture for public use.



KLIMPFJÄLL dining table. Tested and approved for use in public areas, such as restaurants, which means it is extra hardwearing and stands up to extensive, everyday use.

Dining chairs



RÖNNINGE bar stool is made of birch which gives it a genuine feel and a hardwearing surface that will last for years and grow more graceful with age.



YNGVAR bar stool. The clean, simple design is easy to place in a restaurant, café or quick seating zone.



A perfect match with **KLIMPFJÄLL dining table** and other tables with space for 3 or more on either side.



STENSELE table. A round café table with a sleek and stable design that's perfect for casual chit chat and a bite to eat whether in a restaurant or office setting.



STENSELE table. A square café table with a sleek and stable design that's perfect for casual chit chat and a bite to eat whether in a smaller office or conference setting.



STENSELE bar table. A round bar table with a sleek and stable design that's perfect for casual chit chat and a bite to eat whether in a restaurant or office setting.



YNGVAR chair. Hang the chair on the table to clear the floor space for easy cleaning.



JANINGE bar stool. Durable enough for restaurant use - with a design you want to take home.



KYRRE stool. This stackable, 3-legged stool with bent legs and triangular-shaped seat is a great little accent that's comes in handy when you need extra seating.



NORRÅKER table. Each table expresses straightforward Scandinavian design in birch with varying grain patterns and natural colour shifts. Approved for public use.



MÖRBYLÅNGA table. The table has a full plank design that gives it an authentic plank expression with a genuine wood feeling.

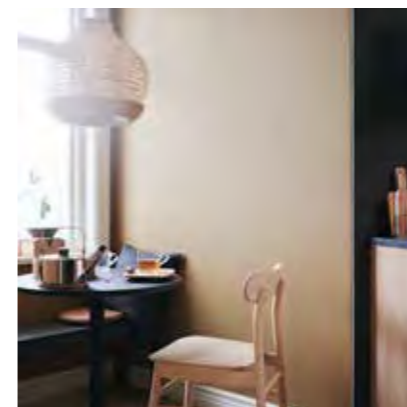

RÖNNINGE chair. The solid hardwood is durable and sturdy - able to withstand many years of heavy use.



The grains of the wood are visible and create a warm and natural expression.

Armchairs



OSKARSHAMN wing chair, D86×H99×W82 cm. Seat depth 54 cm, seat height 44 cm, seat width 54 cm. The wing chair has a high comfort level thanks to the seat with a combination of supportive springs and soft foam, lumbar support, armrests and an extra-high backrest that you can lean against.

GUNNARED black/grey	505.216.63
Tibbleby beige/grey	905.236.22
Tonerud red	305.216.78



HERRÅKRA armchair. The backrest, armrests and low seat together provide a supportive comfort with an embracing feel. W71×D66×H73 cm. Seat width 49 cm, seat depth 45 cm, seat height 44 cm.

Diseröd dark yellow	805.355.45
Skulsta black	805.355.50
Vissle grey	205.447.17



BINGSTA armchair. Soft, rounded armrests and back cushion provide you with your own comfortable nook which feels snug thanks to the solid and curved back panel. W70×D58×H76 cm. Seat depth 48 cm, seat height 45 cm.

VISSELE dark grey/ Kabusa dark grey	604.542.29
Vissle dark yellow / Kabusa dark yellow	104.556.55



FRÖSET easy chair. A sustainable choice since FRÖSET easy chair is durable, made entirely of layer-glued wood and optimally packaged to minimise environmental impact when transported. W59×D57×H74 cm. Seat width 59 cm, seat depth 46 cm, seat height 38 cm.

Bblack stained oak veneer	404.235.59
Red stained oak veneer	204.296.04
White stained oak veneer	804.256.41

Laptop tables and side tables



TUNSTA side tbl 70x50

Anthracite	502.995.02
------------	------------



MITTZON laptop table with castors. The tabletop can be tilted to 6 different positions. Topper keeps your device in place when tilting the top.

Green	704.981.95
White	005.156.07
Black	005.155.94

Dining tables



RÖNNINGE bar table.
H105×L75×W75 cm.

Birch 505.112.30



KLIMPFJÄLL dining table,
L240×W95×H75 cm. The trestles and
hardwood surface create a warm,
traditional expression that will soon
make the double pedestal/trestle
table the natural gathering place for
your colleagues.

Grey-brown 304.346.57



STENSELE table, anthracite/anthra-
cite. You can hang essentials like your
bag or jacket within convenient reach
on the two hooks underneath the
table top.

H75×Ø75 cm 792.882.30



STENSELE bar table. Sturdy yet light-
weight and easy to move thanks to
the hollow steel leg and four-legged
aluminium base.

H105×Ø70 cm 092.882.24



NORRÅKER table, birch.

L125×W74×H74 cm 304.289.82

L74×W74×H74 cm 904.289.84



MÖRBYLÅNGA table, oak veneer brown stained. Tested and approved for use in
public areas, such as restaurants, which means it is extra hardwearing and stands
up to extensive, everyday use.

L220×W100×H74 cm 202.937.66

L140×W85×H75 cm 503.862.45

Dining chairs



RÖNNINGE chair. W46×D49×H79 cm.
Seat height 45 cm. Tested for 110 kg.

Birch 104.225.04



YNGVAR chair. W53×D51×H71 cm.
Seat height 46 cm. Tested for 110 kg.
You sit comfortably thanks to the gen-
erous size and the soft rounded shape
of the seat and back support.

Anthracite 804.176.36



NORRÅRYD chair. W47×D51×H83 cm.
Seat height 46 cm. Seat height 45 cm.
Tested for 110 kg.

Black 402.808.43



RÖNNINGE bar stool.
D39×H75 cm. Seat height 75 cm.
Tested for 110 kg.

Birch 905.112.33



NILSOLLE bar stool.
W39×D39×H74 cm. Tested for 110 kg.

Birch 104.621.23



YNGVAR bar stool. W53×D51×H99 cm.
Seat height 75 cm. Tested for 110
kg. Durable and sturdy, meeting the
requirements on furniture for public
use.

Anthracite 604.007.45



JANINGE bar stool. Ø42 cm. Tested
for 110 kg.
W38×D36×H84 cm. Seat height 76 cm.
Min seat height 56 cm.

Grey 102.813.54

White 702.460.89



KYRRE stool. W42×D48×H45 cm.
Tested for 110 kg

Bright blue 805.555.57

Birch 604.169.25

Black 704.349.76

White 004.915.31

Lighting and accessories

Good lighting plays an important role in enhancing productivity and well-being in the workplace. Not only does it help to increase the aesthetic appeal, good lighting also helps to prevent tiredness as well as strain on eyes, neck and back as a result of weak or poorly directed light. The IKEA range includes different types of lighting to cover your very needs, it also has accessories such as bulbs, cables, sockets, cable holders and more to make your place of work efficient and comfortable.



Different types of lighting for your workspace

When furnishing your workspace with light, it is good to know how different types of lamps spread light and how they can be combined to fulfil the various needs in the office. Good workspace lighting includes a combination of task lighting, general lighting and daylight that does not produce glare or reflections on the work surface. It also requires mood lighting to reduce sharp contrasts.

General light



Mood light

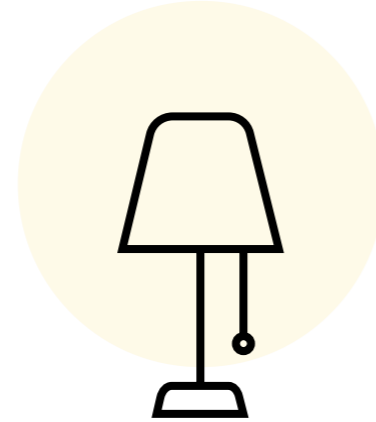

Task light

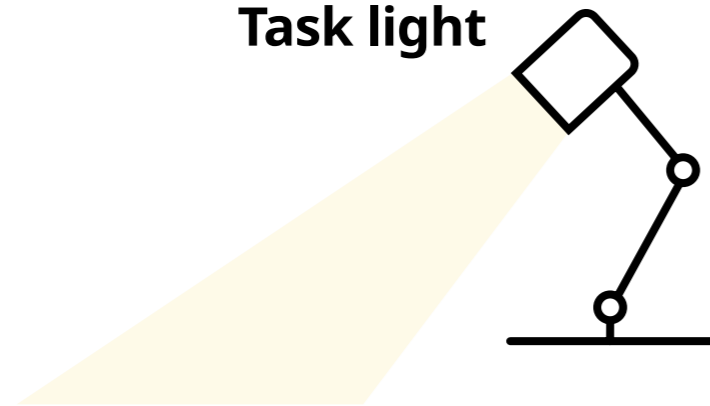

General light

General lighting, often from ceiling lighting provides a uniform light level throughout the entire room. It does not create significant shadows or sharp contrasts between lit and unlit areas. This type of lighting is ideal to create a good overview. Larger spaces often require larger fixtures to spread light. Larger pendant lamps can be a good way to spread an even light while enhancing the style of your interior. If you don't want the ceiling lighting to be the focal point, you can choose more discreet ceiling lamps.



Task light

Task lighting provides a concentrated beam of light over a limited area to enable specific tasks such as working at the desk or computer, or reading documents in a lounge area. Desk lamps and floor lamps with adjustable arms and head for directing light are good choices for flexible and effective task lighting.

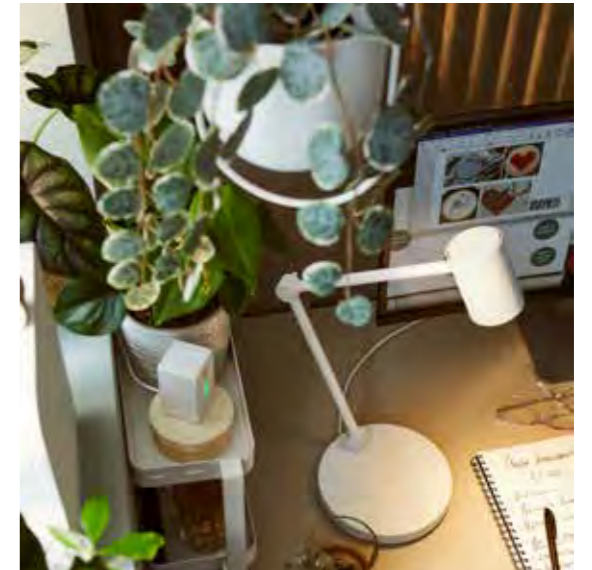

Mood light

Mood lighting softens the contrasts between general and task light to create a cosy, intimate setting. To create inviting mood lighting, you can place table lamps in windows, shelves and cabinets where they illuminate at a suitable height. Floor lamps can be placed to light up dark corners. With little effort, your workplace becomes more appealing, relaxing and enjoyable to work in.



SKYDRAG – a perfect fit for MITTZON



MITTZON frame with castors combines perfectly with SKYDRAG LED lighting strip with sensor. When you dress the frame with display shelves and/or containers, you can also add the LED lighting strip to highlight objects or to create ambience in your workplace. The cables are nicely hidden as you can lead them through the frame interior.

With TRÅDFRI driver and RODRET wireless dimmer or STYRBAR remote control, you can easily turn on/off and dim your lighting. It is also possible to connect the lighting (and other smart products in our range, such as speakers or air purifiers), to the DIRIGERA hub which allows you to control them via the IKEA Home smart app on your mobile phone.



MITTZON frame with castors/container/cable box,
85×205 cm.
White

395.146.78



SKYDRAG LED worktop/wardrobe lighting strip
with sensor, white, dimmable.

60 cm	105.293.74
80 cm	605.293.76



TRÅDFRI driver for wireless control, grey, smart.

10 W	503.561.87
30 W	603.426.56



FÖRNIMMA power supply cord, 3.5 m.

104.468.83



RODRET Wireless dimmer/power switch, smart.

White	805.597.96
-------	------------



STYRBAR remote control, smart.

White	004.680.45
Stainless steel	604.883.66



DIRIGERA hub for smart products, smart.

White	505.034.09
-------	------------



We continuously update the IKEA Home smart app with new and improved features for an even more fun and convenient way to use your smart home.



Complete your combination with lighting

How to build

SKYDRAG LED lighting strip is easy to install on your own.

- For MITTZON frame with castors, choose the 80 cm wide lighting strip to get sufficient light over the width of the frame. Place one lighting strip on the metal bar above each display shelf and/or container that you want to illuminate. You can easily hide the cable(s) inside the MITTZON frame for a tidy look.
- Connect each lighting strip to the TRÅDFRI driver (sold separately) and connect the driver to the plug using FÖRNIMMA power supply cord (sold separately). Hide the driver and cables inside the cable box at the bottom of the frame.
- You can easily turn on/off and dim your lighting or control the entire combination at the same time when you pair RODRET wireless dimmer or STYRBAR remote control with TRÅDFRI driver (sold separately).
- It is also possible to connect the lighting (and other smart products in our range, such as speakers or air purifiers), to the DIRIGERA hub (sold separately) which allows you to control them via the IKEA Home smart app on your mobile phone.

Note: You can connect several lighting strips to TRÅDFRI driver as long as the total wattage does not exceed the driver wattage.

Basic parts



SKYDRAG
LED worktop/wardrobe
lighting strip with sensor



TRÅDFRI
LED driver



FÖRNIMMA
power supply cord



RODRET
wireless dimmer



STYRBAR
remote control



DIRIGERA hub

Installation accessories

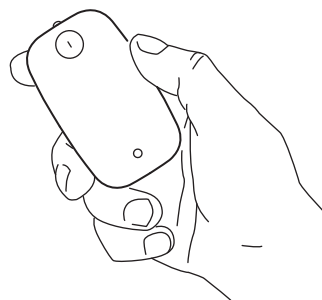
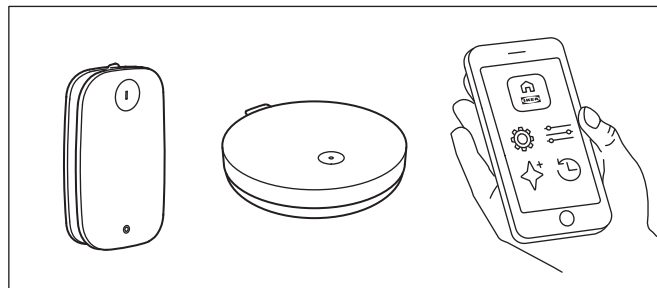
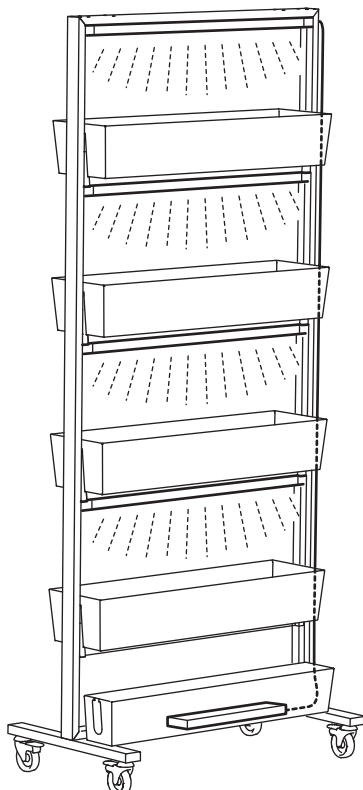

General light

Ceiling lamps

Our range of spotlights, flush ceiling lamps and pendants provide good general light and add an element of style. Whether you want an industrial feel, a natural touch or a retro vibe, we have a ceiling lamp for your workspace.



SKURUP pendant lamp.
Ø38 cm.
Black 807.071.14



SKURUP pendant lamp.
Ø19 cm.
Black 803.973.94



SKYMNINGEN pendant lamp.
Ø42 cm.
White 405.283.54



AGUNNARYD pendant lamp with 3 lamps. L122 cm.
Black 303.421.63



BUNKEFLO pendant lamp.
Ø36 cm.
White/birch 604.883.90
Red/birch 205.591.72



NYMÅNE LED pendant lamp.
Ø38 cm.
White 605.260.47



KAPPELAND/HEMMA pendant lamp.
Ø45 cm.
Rattan/white 995.257.87



KAPPELAND/HEMMA pendant lamp.
Ø29 cm.
Rattan/white 195.256.30



BLÅSVERK pendant lamp, Ø37 cm.
Beige 605.209.03



NYMÅNE ceiling spotlight with 1 spot. Base Ø38 cm.
White 004.247.87



NYMÅNE LED ceiling lamp.
Ø45 cm.
White 603.362.74



NYMÅNE ceiling spotlight with 4 spots. L73 cm.
Anthracite 804.150.86
White 703.377.01



SKURUP ceiling track, 3.spots. L96 cm.
Black 103.959.25



Task light

Floor/reading lamps

Our floor lamps with flexible heads allow you to direct the light straight onto what you are reading. Ideal in a lounge area or cosy corner with armchairs where employees can work in a relaxed atmosphere.



NYMÅNE floor/reading lamp.
H170 cm.

White	903.367.86
Anthracite	104.337.34



NYMÅNE floor lamp with 3.spot.
H160 cm.

White	104.554.86
-------	------------



RÖDFLIK floor/reading lamp.
H140 cm.

Light beige	805.619.40
Grey.green	805.635.76

Desk lamps

Our desk lamps make it easier to focus on the tasks in front of you and come in a variety of styles. For effective lighting, choose a lamp with a flexible arm and head to direct light exactly where you need it.



FORSÅ desk lamp.
H35 cm.

Nickel.plated	101.467.66
Brass	903.995.66
Black	801.060.12
Beige	705.136.43



NÄVLINGE LED desk lamp.
H52 cm.

Black	404.049.09
White	904.049.21



NYMÅNE desk lamp with wireless charging. H67 cm.

White	204.486.07
-------	------------



HEKTAR desk lamp with wireless charging. H70 cm.

Dark grey	203.234.38
-----------	------------



MODERMOLN desk lamp.
H60 cm.

Chrome.plated	105.464.63
---------------	------------



LÖVMÅNAD work lamp.
H30 cm.

Black	705.184.43
-------	------------

Mood light

Table lamps

Sometimes table lamps are just what a room needs to make it feel a bit cosier. With the right choice, you can create a statement or add a bit of personality to your workplace.



DEJSA table lamp.

H28 cm.

Beige 604.049.89



BLÄSVERK table lamp.

H36 cm.

Beige 905.209.30

Blue 805.209.16



BLIDVÄDER table lamp.

H50 cm.

Beige 605.141.67



ÅRSTID table lamp.

H55 cm.

Brass/white 603.213.76

Nickel.plated/
white 002.806.37

Wall lamps

Wall lamps do not take up any floor space and can brighten corners of even the most light-deprived spaces. They also add accent and help create a warm and welcoming ambience in your workplace.



MÄNALG wall lamp.

W35xH29 cm.

Sedge 604.846.98



SINNERLIG wall lamp.

W19xH34 cm.

Bamboo 705.512.15



VARMBLIXT LED wall lamp.

Ø50 cm.

White 505.314.69



**NYMÅNE Wall up/downlighter,
wired.in.** H15 cm, Ø7 cm.

White 603.978.61

Anthracite 204.152.11

Floor lamps

Floor lamps supplement the overall lighting in the workplace, helping to reduce glare while also elevating the ambience. They are a good choice for lighting up dark corners or creating a cosy nook with armchairs for relaxation.



ÅRSTID floor lamp.

H155 cm.

brass/white 403.213.20

Nickel.plated/
white 901.638.65



LAUTERS floor lamp.

H119-151 cm.

Ash/white 404.050.46



ÖKENSAND floor lamp.

H154 cm.

Beech/white 005.415.31



SINNERLIG floor lamp.

H127 cm.

Bamboo 605.012.16

Accessories

The IKEA range includes a wide range of accessories such as cables, chargers, sockets, cable holders and more to make your place of work efficient and comfortable.



KALKSTUFF cable holder, set of 3.

Dark grey	305.557.05
White	605.557.04



HAVSKÅL, 2-piece, USB anchor.

Black/yellow	405.372.83
--------------	------------



KOPPLA 4-way socket.

White	304.120.33
-------	------------



KOPPLA 3-way socket with 2 USB ports.

White	702.809.93
-------	------------



KOPPLA 6-way socket with switch.

White	404.120.23
-------	------------



SJÖSS 30W 1-port USB charger.

White	005.744.56
-------	------------



SJÖSS 45W 2-port USB charger.

White	805.744.57
-------	------------



LILLHULT USB-A to lightning, 1.5 m.

Dark grey	405.811.05
-----------	------------



LILLHULT USB-A to USB-C, 1.5 m.

Black/white	905.811.03
-------------	------------



LILLHULT USB-C to lightning, 1.5 m.

Green	205.811.11
Grey	405.811.10
Orange/pink	005.811.12



LILLHULT USB-C to USB-C, 1.5 m.

Green	005.810.94
Light grey	405.810.92
Orange/pink	205.810.93



**RUNDHULT USB-C to USB-C,
1.5 m/100W.**

Black/white	205.811.06
Dark grey	005.811.07

Greenery and wall decoration

Enhancing your office space with carefully selected wall decoration and greenery may be just what you need to make your space feel more inviting, comfortable and inspirational. A large print with an inspirational motif, a framed message to reflect your company's mission or a mirror to add both style and practical use. Small details like these can make a big difference. When you also include some plants and pots, you not only enhance the aesthetic appeal, you are making the environment more vibrant and harmonious.

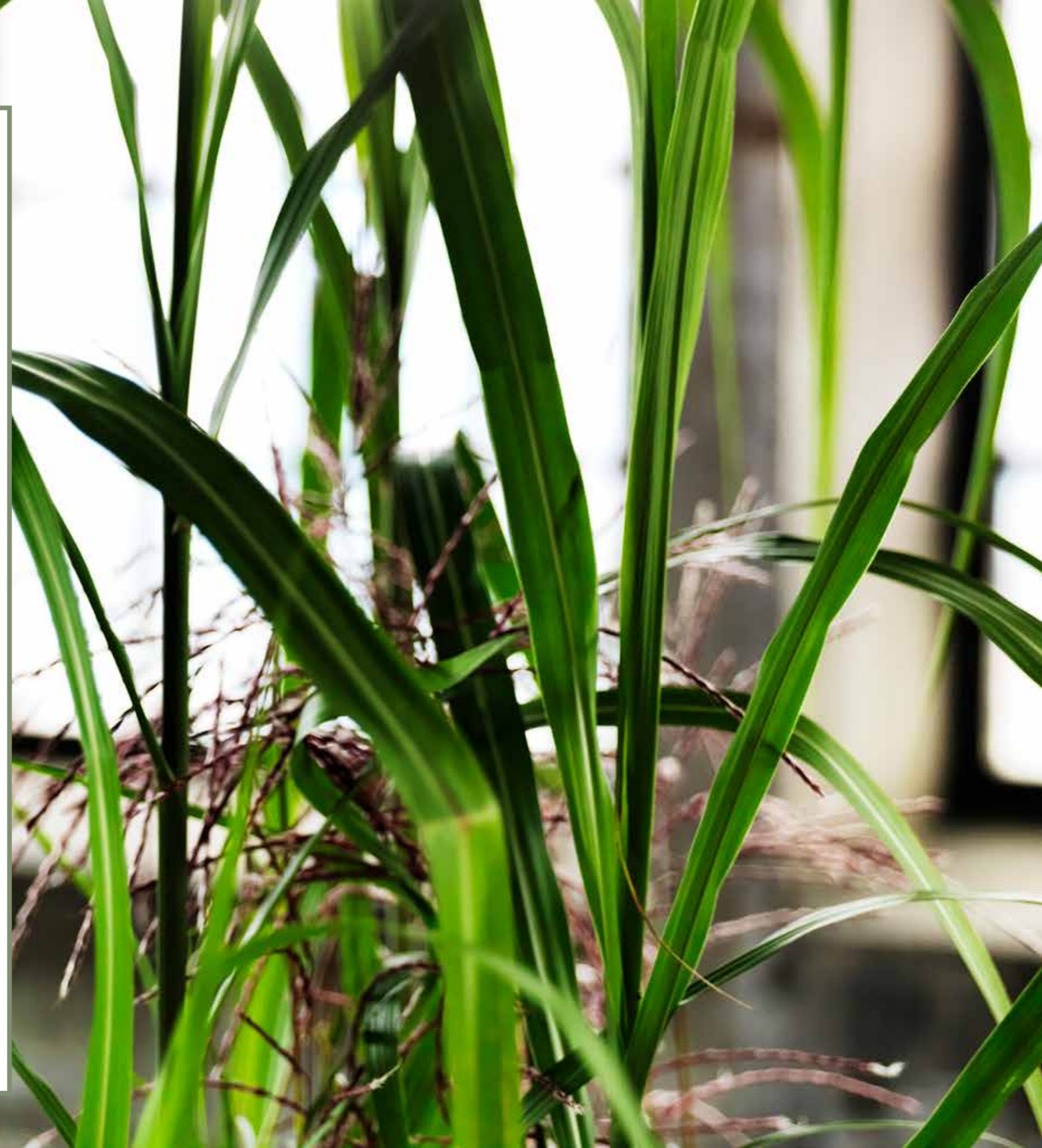

Let the greenery work

Invite greenery in to your workspace and let the vibrant, lush leaves inspire. Choose your favourite plants, from small to large, and combine with suitable plant pots from our large selection to create a style and look that harmonises with your office. If you are looking for less maintenance, artificial greenery may be the perfect choice – they look fresh and stay happy without the need for sunshine or watering.



Cultivate great ideas in your green oasis

Add a pop of green with small plants on a desk or shelf, or use large plants to create an impactful impression. Large plants or multiple small plants together can also be functional in unexpected ways – why not use them as lush room dividers to partially screen off an area, creating a feeling of privacy in your own calm oasis?



Wall decoration

Dress your walls with function and personality!

Where there's a wall there's an opportunity to enhance the atmosphere in your workspace while also adding practical benefits. Whether it's a wall space in the entrance, meeting room or office canteen, our range includes a wide variety of wall decorations to help complete your workspace.

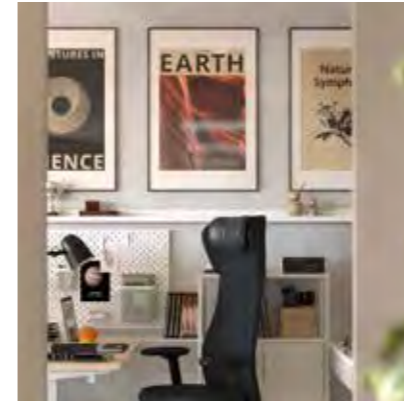

Wall frames

A message or motif in a frame can turn a wall into a point of interest. LOMVIKEN and RÖDALM frames come in sleek designs that blend easily in most office spaces. Ideal for framing inspirational quotes, information or artwork.



Pictures and artwork

Have a large empty wall? BJÖRKSTA pictures with frames offer a variety of motifs so you can pick the perfect one for your office space, lounge area or waiting room – all are generously sized to make an impression.



Wall clocks

Every room in the office can do with a clock on the wall. Our range includes a variety of wall clocks that bring character and practical function to the workspace. BRAVUR wall clock is ideal for large, open spaces like the entrance or office canteen. The smaller BONDIS and PUGG wall clocks are perfect for meeting rooms and hallways.

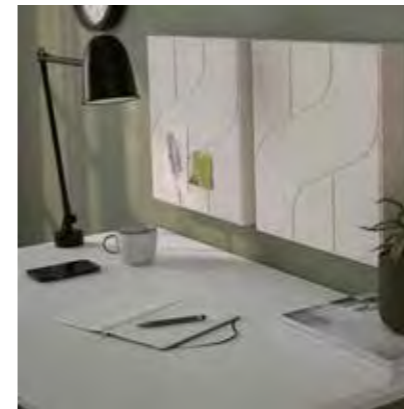

Decorations

Textiles on walls can add detail and warmth to the room. Decorative NÄVERHÄGG panels up the cosy factor and can help dampen sound levels – they can also be used as pinboards to hang notes.



Mirrors

A good mirror is essential for checking your hair and outfit when arriving at or leaving the office. Timeless LINDBYN and NISSEDAL mirrors come in a variety of shapes and sizes and are a perfect complement to the coatroom.



Photo frames

A small, standing frame like FIKONTRÄD, is perfect for displaying information in a dining area or at a reception desk.

Plant pots, plant accessories and artificial plants



CHILISTRÄN hang planter, in/outdoor, white.

12 cm 704.922.64



FRIDFULL plant pot, water hyacinth.

12 cm 901.558.70
24 cm 705.134.12



KLARBÄR plant pot with saucer, in/out, grey-brn.

15 cm 805.084.29



PERSILLADE plant pot, dark grey.

12 cm 003.157.26
19 cm 903.467.66
24 cm 103.467.65



IKEA PS 2002 water can, white.

1.2L 602.899.46



SATSUMAS plant stand, bamboo/white.

70 cm 902.581.56
78 cm 402.581.54



FEJKA artificial potted plant, in/outdoor, Monstera.

19 cm 403.952.88



FEJKA artificial potted plant, in/out, Areca palm.

12 cm 305.084.03



FEJKA artificial potted plant, in/outdoor, hanging/
eucalyptus.

9 cm 704.668.11



FEJKA artificial potted plant, In/outdoor, Weeping
fig.

21 cm 704.915.75



FEJKA artificial potted plant, In/outdoor, tradescan-
tia zebrina.

12 cm 605.465.78



FEJKA artificial potted plant, in/outdoor, hanging/
fern.

12 cm 105.486.31

Wall decoration



FIKONTRÅD frame, white.

10×15 cm 605.187.16

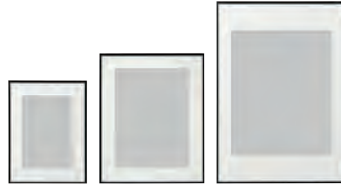

LOMVIKEN frame, black.

30×40 cm 502.867.69
40×50 cm 702.867.68
50×70 cm 702.867.73



RÖDALM frame.

Black

30×40 cm 205.489.18
40×50 cm 905.489.10

White

30×40 cm 405.489.22
40×50 cm 805.489.15



BJÖRKSTA picture with frame, curious cow.

140×100 cm 495.089.12



BJÖRKSTA picture with frame, bridge and clouds, black.

200×140 cm 195.089.37



BRAVUR wall clock, black.

59 cm 605.404.73



BONDIS wall clock, black.

38 cm 105.430.92



PUGG wall clock, stainless steel.

32 cm 905.408.53



LINDBYN mirror, black.

60×120 cm 304.586.10



NÄVERHÄGG sound absorbing panel, decoration/ grey, 2p.

41×41 cm 604.925.18

Services

Our broad service offer gives you the freedom to decide how much you want to do yourself and how much you want us to do for you.

Below you'll find all the services that we can offer. Find out more at www.ikea.co.uk/services



Finance services

Simple, quick, and flexible, our finance services offer 0% APR credit for every type of project, big or small



Planning services

Online or offline, schedule a free appointment with a specialist for personal interior advice or to design a smart storage solution.



Delivery

Explore our prices, weight limitations and lead times and find out which delivery method suits you best



Buyback

A second life for your old furniture, an IKEA voucher for you



Assembly and at-home services

We can build your IKEA furniture for you and tackle your other home improvement plans, with services from wall mounting, painting and decorating to gardening



Click and collect

All about control and convenience? Collect from an IKEA store for free or a local pick-up point

New

MITZON
Laptop table, 66x50cm. White.
005.156.07





MITZON
foldable table with castors.
140×70 cm, white.
205.279.54

Ideal for collaboration spaces and meeting rooms that need to be adapted easily to different needs. 10-year guarantee. Read about the terms in the guarantee brochure.

